

5.0 PROJECT DESCRIPTION

This chapter provides a description of the Côté Gold Project (the Project) as currently proposed by the IAMGOLD Corporation (IAMGOLD). The overview of the Project, as well as its location and preliminary site plan are presented in Chapter 1 (see Figure 1-1 and 1-2 respectively).

A description of the regional and property geology is discussed in Chapter 6. The Project area is located in the Swayze greenstone belt, an extension of the Abitibi greenstone belt located within the Superior province. The Swayze belt contains both extrusive and intrusive rocks with compositions ranging from ultramafic to felsic. The Côté Gold deposit is hosted within the Chester Granitoid Complex (CGC), which is the northern edge of the Ramsey-Algoma granitoid complex. Generally, the Project site is located within an area with moderately hilly boreal mixed wood forest, bogs, fens and lakes commonly less than 10 m deep. Elevations range from 375 m above sea level (masl) to 425 masl, averaging approximately 400 masl near the Project site.

The area of the Project has a gently rolling topography that seldom exceeds 50 m from the lowest point in the Project site area. The higher ground usually has a veneer of glacial soil over bedrock, with thicker overburden present in the low-lying areas between the hills.

5.1 Main Project Components and Activities

The preliminary site layout places the required mine related facilities in close proximity to the proposed open pit, to the extent practicable, primarily on private, patented lands owned fully and/or jointly by IAMGOLD. The preliminary site plan showing the proposed Project site is shown in Figure 1-2, and the proposed Project footprint will cover approximately 1,700 ha (17 km²) during operations, without the transmission line alignment footprint. This preliminary site plan shows the preferred alternatives for Project components and/or their locations, which were assessed and are described in Chapter 7. The proposed transmission line alignment (TLA) alternatives are shown in Figure 5-1.

The generalized site plan reflects current Project planning and suggested areas of proposed development rather than actual design features, recognizing that there are various alternatives that are still under consideration as part of overall Project planning and Environmental Assessment (EA) evaluations. As such the locations and scale of some Project components could change as ongoing engineering studies progress and as further consultation with the general public, Aboriginal groups and government agencies occurs.

The Project is designed to:

- respect the interests of other land uses and users in the area;
- use well-known, conventional and environmentally sound mining and processing technologies commonly used in northern Ontario, based on IAMGOLD's experience with other gold mining operations;
- minimize the overall footprint and associated potential effects;

- manage water effectively and efficiently;
- mitigate or compensate for effects on fish and fish habitat; and
- accommodate effective planning for final closure and site abandonment, rendering the site suitable for other compatible land uses and functions.

5.2 Existing Facilities and Infrastructure

The Project site and surrounding area are mainly characterized by gentle hills, forests, lakes, and rivers. Land use in the general area consists of recreational activities by locals and tourists, including fishing, camping, and hunting. It is also extensively used for sustainable harvesting of timber.

As the site is an active exploration area, there are a number of exploration-related facilities, such as drill pads and associated equipment, used to define the current mineral resource as well as to investigate soil and groundwater conditions.

Mineral exploration of the Project site has been carried out since about 1900 by various companies and government agencies and has continued sporadically to the present time. More concerted mineral exploration efforts were conducted in the early 1940's and from the early 1970's to about 1990. Since its discovery in 2010, extensive diamond drilling activities have been undertaken to delineate the Côté Gold deposit. As of December 31, 2012, the Côté Gold drill hole database contains results of 293 diamond drill holes for a total of 158,047 m.

Continued overburden test pitting and drilling will provide detailed information on the stability of the overburden in order to support design of the open pit slopes, the Mine Rock Area (MRA), the Tailings Management Facility (TMF) and other site infrastructure.

5.3 Open Pit Mine

5.3.1 Open Pit Design

The current open pit design proposes a final pit measuring approximately 210 ha (2.1 km²) with a depth of approximately 550 m. Open pit mining will occur at a mining rate of approximately 60,000 tonnes/day (tpd) of ore production. Extraction of the ore through pit development will result in the production of an approximately estimated 20 million tonnes (Mt) of overburden and 850 Mt of mine rock. As currently proposed, open pit mining will occur over an approximate 15 year period.

The pit wall slopes will be designed for safety based on applicable industry standards. The benches in rock will be developed by blasting, using variable portions of emulsion, or emulsion-blend explosives, and ammonium nitrate/fuel oil (ANFO). It is currently foreseen that a sump or sumps will be created at the base of the open pit for water management. Alternative means for pit dewatering, such as perimeter and in-pit wells and drainage holes in the pit walls, may also be investigated.

5.3.2 Site Preparation

Before mining of ore can commence in the Project open pit, a series of activities must first occur:

- initiation of overburden stripping;
- establishment of water management and flood protection infrastructure;
- construction of dams and water realignment channels/ditches; and
- construction of support buildings and infrastructure.

5.3.2.1 Overburden Stripping

Site preparation for mining will involve overburden removal (stripping) to gain access to the bedrock and allow extraction of ore. As mentioned above, Project development is expected to generate approximately 20 Mt of overburden, which will be stockpiled for permanent disposal on site along with mine rock in the MRA, with a portion of the overburden used for final site reclamation activities.

At the proposed open pit location, overburden ranges from approximately 0.1 m (exposed bedrock) in the higher elevation lands to 22 m thick in low-lying areas, averaging at a depth of 7.7 m over most of the proposed open pit area. This material will be stripped progressively from the start of the construction phase and continue for the first part of operations. Excavated overburden will be stripped from the pit surface using diesel and electric shovels, excavators, dozers and/or comparable equipment, and will be transported by haul truck to the MRA, or alternatively, trucked directly to the applicable construction site if intended for re-use (e.g., to the TMF).

5.3.2.2 Surface and Mine Water Management

As part of the proposed development of the open pit, Côté Lake will need to be drained. Additionally, portions of Three Duck Lakes, Clam Lake, Bagsverd Creek and the Mollie River system will be dammed and/or require realignment to allow safe operation of the open pit as well as the TMF. The proposed watercourse realignments are detailed in Section 5.10.

Open pit dewatering will start during overburden stripping and will continue during mining operations. Surface water runoff will be diverted from entering the pit by ditching or other means. This will reduce the quantity of water flowing over the overburden slopes and the quantity of water interacting with mining operations that will require pumping and possible treatment if required. Runoff and seepage will be diverted to the mine water pond. Water collected within the open pit sump, such as from direct precipitation, overburden seepage and groundwater inflow, will be pumped to the surface for transfer to the mine water pond.

Water from the open pit sumps will form part of the recycled water at the mine water pond to help satisfy the water requirements for the ore processing plant. Mine water management from the pit is further discussed in Section 5.4.

5.3.3 Open Pit Mining

The mining method will be a conventional shovel and truck type operation.

The open pit mine is currently expected to operate on the basis of two 12-hour shifts or three 8-hour shifts, 365 days per year, with a typical ore output of 60,000 tpd. The mine life is expected to be approximately 15 years. Rock will be broken at the face using explosives and will be loaded using a hydraulic shovel (diesel or electrical) onto 225 t off-highway haul trucks for transport to the primary crusher or stockpiles (overburden and mine rock to MRA, or to low-grade ore stockpile). Ramp widths will be designed to accommodate the necessary heavy equipment.

Approximately 0.3 kg of explosives is expected to be consumed for each tonne of ore or mine rock mined, and blasting will be carried out 5 times per week during normal operations. A maximum blast charge per delay of approximately 536 kg has been determined for the open pit during normal operations. Dust control measures will be implemented during all phases of the Project, as required. Explosives storage and preparation is further detailed in Section 5.11.1.

As a result of the significant depth of the proposed open pit, the mining method may ultimately include in-pit crushing and conveying to reduce operating cost. In-pit crushing and conveying (IPCC) would involve the utilization of a primary crushing system capable of being relocated on an infrequent basis progressively deeper within the confines of the pit to minimize the vertical haulage component carried out by the haul trucks.

The primary mining fleet will consist of rotary blast hole drill rigs, mining hydraulic shovels, loaders and 225 t haul trucks. Dozers, graders, auxiliary excavators and other miscellaneous support equipment will support the fleet.

In total, an estimated 261 Mt of ore will be mined from the open pit over the Project life and processed on site. A portion of this quantity is low-grade material that will be stored northeast of the open pit for processing later in the mine life.

5.3.4 Open Pit Material Geochemical Characterization

A total of 35 selected overburden materials have been characterized from the proposed open pit area (see Appendix E). The following are key findings of the characterization work completed:

- open pit overburden materials generally do not have a net potential for acid rock drainage (ARD);

- generally low concentrations of total sulphur (<0.03%) were observed with mostly similar proportions of sulphate and sulphide;
- a maximum sulphide content of 0.05% was observed;
- some shallow (<0.9 m depth) soil samples are neutralization potential (NP) depleted (negative NP and depressed paste pH) presumably due to weathering exposure at surface;
- a wide range in NP predominantly as carbonate is present in pit overburden materials (in the order of <1 to more than 200 kg CaCO₃/t);
- no potentially acid generating (PAG) samples were identified on the basis of NP Ratio (NPR) <2; and
- exceedances of the Ontario Typical Range agricultural standards were reported for copper in four of 35 samples (three samples also exceeded the residential, parkland, commercial and industrial (R/P/C/I) standard).

Five selected sediment materials have been characterized from the following four lakes in the region of the future proposed open pit: Clam Lake, Côté Lake, Three Duck Lakes and Unnamed Pond. The following are key findings of the characterization work completed:

- the sediment materials exhibit a low potential for ARD;
- generally low concentrations of total sulphur (<0.07%) variably mixed in proportion as sulphate and sulphide were identified in the sediments.
- a maximum sulphide content of 0.05% was present in an organic rich, high NP Côté Lake sediment sample;
- a wide range in NP predominantly as carbonate was observed from site to site (in the order of 1 to just under 150 kg CaCO₃/t);
- there is a generally low potential for ARD from these materials and no PAG samples were identified on the basis of NPR <2 or Carbonate NPR <2; and
- exceedance of the Ontario Typical Range Sediment copper standard has been reported for three of the five samples with two of these also marginally exceeding the Sediment standard for nickel.

An extensive characterization program of mine rock from the proposed open pit has been completed. The following are the key findings of the characterization work completed:

- ARD potential:
 - most mine rock sampled exhibited little potential for metal leaching (ML)/ARD;
 - generally low concentrations of total sulphur (<0.24% at 90th percentile) predominantly as sulphide are observed;

- the maximum reported sulphide content was 1.4% and the most commonly observed sulphide is pyrite;
- the materials exhibit a wide range in NP predominantly as carbonate (in the order of 1 to 450 kg CaCO₃/t);
- calcite is the most commonly observed carbonate mineral with lesser amounts of dolomite and sometimes ankerite identified;
- most samples are non potentially acid generating (NAG) (NPR >2), mean NPR of the mine rock was 19;
- a proxy approach using Leco C and S¹ analysis to estimate NP and maximum potential acidity (MPA) was proven to be reasonable as a stream-lined approach to guide future ARD characterization work for Project mine rock;
- approximately 5% of acid base accounting (ABA) (reference) samples were PAG based on NPR <2 and 7% of ABA samples were PAG based on NPR_{MPA} <2;
- approximately 5% of Leco carbon/sulphur samples (1100 sample expanded data set) were PAG based on NPR_{MPA} <2; and
- a small sub-set of the ABA (reference) samples have been identified with low NP (<10 kg CaCO₃/t) that may contain Fe carbonates that are not well characterized by the proxy approach using Leco C and S. All but one of these samples contained very low sulphide content.

Considering the limited proportion of PAG samples identified, the overall low sulphide content of the rock, and the prevalence of non acid generating rock to be produced as waste, the likelihood of net acid conditions occurring in the mine rock piles is considered to be very low. Therefore the inclusion of any PAG materials with the bulk of the waste will likely be an appropriate management method and segregation of any PAG materials does not appear to be necessary.

- ML Potential:

- a number of samples exceeded the 10 times crustal abundance screening criteria for arsenic, bismuth, copper and selenium;
- a few samples exceeded the 10 times crustal abundance screening criteria for cadmium and molybdenum respectively;
- available data suggests a generally low potential for neutral ML;
- all short term metal leach results were below O. Reg. 560/94 threshold values;
- a few elements (most frequently vanadium, silver, chromium and copper) in some samples were detected in short term leach test results above the Provincial Water Quality Objectives (PWQO) screening criteria;

¹ Leco carbon (C) and sulphur (S) induction furnace method for analysing total carbon/sulphur present in samples.

- most trace elements (including silver, beryllium, bismuth, cadmium, chromium, iron, mercury, lithium, nickel, phosphorus, lead, selenium, titanium, thallium, thorium, tungsten and zinc) were at or below detection limits in all humidity cell leachates; and
- arsenic, antimony and molybdenum (that can tend to be mobile at neutral pH) were detected at low levels in some humidity cell leachates and copper was detected in leachate only from one PAG cell based on NPR <2.

5.4 Mine Water Management

Mine water will derive from the open pit mining operations and its removal from the open pit will be required continuously for the life of the Project in order to maintain a dry working environment.

The proposed open pit will intercept groundwater and runoff from adjacent areas, as well as direct precipitation. Preliminary analysis indicates that, when fully developed and at a steady state, the open pit will intercept up to an estimated 2,210 m³/d of groundwater from the bedrock per year over the Project life (base case). Potential inflows from overburden seepage are anticipated to be intercepted at the surface before entering the open pit (ditching).

The average annual precipitation over the Project site is approximately 856.3 mm. In a 1:50 year wet annual climate condition, the Project site is projected to receive up to approximately 1,008 mm in total annual precipitation (approximately 250 mm more than the average annual precipitation). In a 1:25 year wet annual condition, total annual precipitation is projected to be approximately 990 mm, and in a 1:10 year wet annual condition up to approximately 959 mm. The probable maximum precipitation (PMP) over 24 h would be up to approximately 506 mm over a 25 km² drainage area.

Mine water will be collected in a series of drains and/sumps at the base of the open pit, which will be progressively relocated as the pit develops over time. Mine water from the open pit, approximately 3,000 m³/d when the open pit is fully developed, and overburden seepage from the pit perimeter drainage, will be pumped to the mine water pond. Water from the mine water pond will be pumped to the ore processing plant as needed and the remainder of the flow will be sent directly to the polishing pond. Well field pumping and/or collection ditches may be considered to supplement mine water collection. No special handling or treatment of snow is considered as accumulated snow in the pit will be removed with the excavated mined materials (overburden, mine rock or ore), or will melt and drain towards the installed sumps.

Mine water is expected to contain suspended solids from general mining and earth moving activities, as well as ammonia and hydrocarbon residuals from ammonium-nitrate based explosives (e.g., ANFO explosives) and heavy equipment operation. Typical ANFO explosives generate ammonia residuals of about 5% to 10% of the ammonia originally present in the explosive material. Emulsion and emulsion blend explosives typically produce a lower ratio of ammonia residuals and are better suited for blasting in wet conditions. Hydrocarbon residuals are usually due to hydraulic hose breaks, fuel leaks and similar mishaps. Measures will be taken

to prevent and clean up any hydrocarbon spills at source to prevent such materials from entering the mine water as practical. Leaching of the exposed bedrock within the open pit may also potentially contribute minor quantities of solid and dissolved phase metals to the mine water. Because of the slow kinetics of mineral oxidation, metals are expected to occur mostly as solid metals.

Ammonia-based residuals will be managed at source through best management practices for explosives handling, and through extended effluent aging in the polishing pond. Pumping mine water from below the sump surface will help keep any hydrocarbon residuals from being pumped to the mine water pond. Hydrocarbon collected in the sumps will be periodically removed as required using oil skimmers and/or similar absorbent materials. The absorbent materials will be appropriately handled and disposed of.

Mine water management during the post closure period and general water and drainage management are discussed in Section 5.10.

5.5 Stockpiles

The principal criteria for selection of the MRA and, to a lesser degree, low-grade ore stockpile, locations were the following:

- Areas within reasonably close proximity to the open pit to minimize the overall Project environmental footprint, to reduce greenhouse gas (GHG) emissions and to achieve economic efficiencies of operation;
- Limit the number of stockpiles – establish fewer but larger stockpiles that can be managed more efficiently, rather than having many smaller, scattered stockpiles;
- Select areas with suitable foundation conditions;
- Minimize adverse effects on visual aesthetics by limiting stockpile height;
- Select areas within a safe distance from water bodies, creeks and fish habitats (maintain 100 m to 150 m distance where possible);
- Position stockpiles in a manner such that drainage from the stockpiles can be suitably collected and managed in accordance with the Federal Metal Mining Effluent Regulations (MMER) and Provincial environmental approval requirements;
- Stockpiles should be at least 300 m from the open pit perimeter;
- Minimize potential adverse effects to aquatic and terrestrial habitats, including potential adverse effects to species at risk (SAR);
- In the case of mine rock, provide for an optimal closure scenario for potential ARD/ML management using passive systems to the extent possible, but with a contingency arrangement for chemical treatment if and where required; and
- Land tenure and existing/potential land uses, including proximity to existing residences/cottages as potential noise receptors.

Based on these criteria, surface locations for potential separate stockpiles were selected (see Figure 1-2 for selected locations). It is anticipated that final stockpile heights could be up to a maximum of 150 m depending on the stockpile footprint and other factors.

5.5.1 Mine Rock Area

5.5.1.1 Mine Rock

Project development is expected to generate approximately 850 Mt of mine rock, and mine rock stockpiles will be located in the designated MRA covering an estimated total area of 400 ha (4.0 km²) with an ultimate elevation of 490 masl. Based on the current design, approximately 40 Mt of mine rock is expected to be used in various Project site construction activities, mainly for the TMF dam and road maintenance/construction.

The MRA will be developed over the life of the Project, with a final overall slope of approximately 2.6 m horizontal width to 1 m vertical height (2.6H:1V). The stockpile layout will include 10 m tall benches with inter-bench slopes at 1.3H:1V and 12.75 m wide mid-slope benches. Overburden present in the proposed MRA area has an average thickness of 9.3 m, with the greatest thickness of 22.6 m observed on the western shore of Middle Three Duck Lakes, similar to overburden conditions of the open pit area.

The stability of the MRA stockpiles will meet or exceed the following minimum safety factors:

- long-term static loading conditions Factor of Safety (FS) = 1.5;
- short-term at end of construction FS = 1.3; and
- pseudo-static FS = 1.0.

Ditching and seepage collections ponds will be placed around the MRA to capture runoff and seepage for water management and monitoring of runoff quality. The collected water will be directed through the collection ponds placed around the MRA towards the mine water pond. The system will be designed to collect the average annual precipitation seepage and runoff, with storage capacity to allow for pumping water to the mine water pond and then to the ore processing plant and/or polishing pond under all climatic conditions.

In general, the rock analysed to date is considered primarily not acid-generating (92%; see Appendix E). Further testing is currently being completed in order to better characterize the rock acid-generating potential. Upon closure, mine rock stockpile drainage will be directed to flow by gravity into the open pit, as needed, to facilitate open pit flooding and be managed as part of the open pit catchment area water management program.

5.5.1.2 Overburden

Overburden will include topsoil, peat and any organic materials encountered during the initial stripping for mine development. Overburden stockpiles will be located within the MRA in the northern section, as these will be managed separately to provide overburden for closure

activities. Overburden stockpiles are designed to have a capacity for 20 Mt of overburden, and will be integrated into the MRA, strategically located to accommodate closure activities.

Overburden slopes are expected to have an overall angle range of 3 m horizontal width to 1 m vertical height (3H:1V), with 10 m high and 12 m thick benches. The slopes may be progressively revegetated to ensure long-term stability and protect them from erosion as needed, which is expected to meet or exceed the same safety factors as for the mine rock stockpiles. The slopes may be further protected from erosion by placing NAG mine rock armouring, as necessary. Ditching will be placed around the overburden stockpile to capture runoff for water management and monitoring of runoff quality. Runoff will be directed to collection ponds as part of MRA water management.

5.5.2 Low-Grade Ore and Other Stockpiles

Any low-grade ore will be stockpiled in close proximity to the surface location of the primary crusher and the ore processing plant, for future processing purposes towards the end of the operation's phase. It is planned that the low-grade ore stock pile will be sited to the east of the ore processing plant and northeast of the open pit perimeter (see Figure 1-2).

The proposed location of the low-grade ore stockpile was determined based on consideration of its proximity to the ore processing plant and open pit to minimize transportation requirements, Project property availability and geological setting (bedrock close to the surface). It is important to note that this specific location was identified, because the construction of a retention dam, which is required to keep Upper Three Duck Lakes at a safe setback distance from the open pit, will expose an area suitable for this application.

Runoff and seepage will be collected and managed similarly to the MRA water management.

A run-of-mine (ROM) stockpile will be required in order to ensure continuous feed to the ore processing plant. The ROM stockpile will also be placed adjacent to the primary crusher to provide the ore material feed to the ore processing plant during operations.

Crushing will yield two crushed-ore stockpiles. These stockpiles are expected to have a live capacity of 3,250 t and 60,000 t, having an overall capacity of up to 160,000 t. The crushed ore stockpiles will be covered with a dome of approximately 100 m in diameter for dust control.

5.6 Processing

Based on the metallurgical test work to date, the ore processing plant will utilize gravity separation and cyanidation for gold recovery. As shown in Figure 1-2, it is currently foreseen that the ore processing plant and crusher circuit will be located in a relatively flat area close to the open pit and the TMF in order to minimize transportation distances for ore and tailings and water piping.

Ore processing will involve crushing and grinding, including coarse gold recovery by gravity, cyanide leaching, carbon-in-pulp gold recovery, followed by carbon stripping and electro-winning to produce a gold sludge, which will be poured in a doré gold bar using an induction furnace.

Results from ongoing exploration activities indicate that the ore may contain copper levels such that extraction of copper could be viable in the long term. It is therefore foreseen that, in the future, the ore processing plant may be expanded to include a copper recovery circuit. However this copper recovery circuit is not included in the scope of the current Project.

5.6.1 Buildings and Structures

The ore will be reduced in size by the crusher circuit and processed in the ore processing plant. The ore processing plant and supporting crusher have been designed to meet the estimated throughput of approximately 60,000 t/d.

The crusher circuit includes the primary crusher, screen, secondary crusher and run-off-mine stockpile with its associated conveying system.

The primary crusher will be located on bedrock outside and adjacent to the ore processing plant, near the open pit exit ramp. The primary crusher building will be built on bedrock and/or appropriately designed concrete pad to ensure equipment stability, with perimeter ditching to capture runoff to be pumped to the mine water pond. In order to facilitate ore dumping and movement the crusher will be below-grade, with a large area for mine truck circulation. The primary crusher building will house the primary and secondary crushers, surge pocket, and apron feeder. Ore will be fed into the primary crusher dump pocket via haul trucks from the ROM stockpile.

All ore processing will take place within the ore processing plant which will also be situated on bedrock and/or appropriately designed concrete pad to ensure equipment stability. The ore processing plant building will house the milling, gravity separation circuit, cyanide leaching with carbon-in-pulp (CIP) gold adsorption, carbon stripping and electrowinning and refining areas, as well as reagent preparation areas and the metallurgical laboratory.

Water will be supplied to the ore processing plant from the mine water pond, located adjacent to the ore processing plant as well as from the TMF pond, the polishing pond and Mesomikenda Lake. Water sources and recycling are discussed in Section 5.10.

The tailing thickeners, leach tanks, lime slaking and cyanide destruction areas are anticipated to be located outside and adjacent to the ore processing plant. Adequate equipment and handling procedures will ensure that cyanide and other reagents are stored and used safely, as is standard for Ontario gold mines.

5.6.2 Comminution

The ore feeding into the crushing circuit from the ROM or low-grade ore stockpile must be reduced in size to a consistency similar to that of sand or silt, in order to optimize further ore processing and gold recovery.

Trucks will dump ore into the dump pocket from the ROM or low-grade ore stockpile. Ore that is too large will be reduced by means of a hydraulic rock breaker at the mouth of the primary gyratory crusher.

The ore will be sequentially reduced in size through a series of steps, anticipated to proceed as follows:

- hydraulic rock breaker as needed to reduce oversized ore to enable feed into the primary crusher;
- primary crushing (gyratory crusher) to reduce the ore feed to <350 mm maximum diameter;
- secondary crushing (cone crushers) to reduce the ore feed to 80% passing 65 mm;
- two semi-autogenous grinding (SAG) mills to reduce the ore feed to 80% passing 2.4 mm or approximately 100% passing <80 mm;
- two pebble crushers to reduce the ore recycle to the SAG mill; and
- two secondary grinding ball mills to reduce the ore feed to 80% <0.100 mm or approximately 100% passing 0.15 mm.

It should be noted that primary and secondary crushing will be carried out on ore without the addition of water. The process will then continue as a wet process, starting with the SAG grinding. A screen will be used to separate oversized material from the SAG mill discharge, which will be crushed by the pebble crusher and recycled to the SAG mill. It should be noted that dust control measures will be employed to reduce potential effects on air quality (see Section 5.14.1).

Process water will be added with the ore to the mill circuit. The ore is milled in two parallel lines of SAG and ball mills, which hold hardened steel grinding balls of varying diameter, with coarse grinding balls of up to 125 mm in diameter. The resulting slurry from the milling process is pumped to a cyclone cluster to be sized before to enter the ore processing circuit.

5.6.3 Concentration and Separation

Using gravity separation will minimize the amount of gold to be leached using cyanide, thereby reducing cyanide consumption.

Large and small ore particles suspended in the post-grinding slurry are separated in the cyclones by means of gravity and hydraulic forces. The smaller ore particles tend to remain in

suspension and these are discharged as cyclone overflow to the leaching circuit. The larger and some smaller but dense ore particles separate out and report to the cyclone underflow. The cyclone underflow will be split into two streams: one going to the ball mill and the other going to the gravity circuit. Approximately 20% of the underflow will be diverted to the gravity recovery circuit, the rest being fed to the ball mills.

The ball mill discharge is combined with the SAG mill discharge and the tailings from the gravity circuit and pumped once again to the cyclone cluster. The overflow from the cyclone cluster is fed to the leach circuit by way of the pre-leach thickener.

In the gravity separation circuit, gravity concentration takes advantage of the high specific gravity of gold to separate the heavier gold particles from the less dense rock particles, to produce a concentrate with low mass and a high gold content. The gravity concentrate will then be leached in an intense cyanidation reactor, to produce a pregnant solution laden with gold. The tailings from the gravity separation circuit will be returned to the ball mill circuit.

5.6.4 Leaching and Carbon Adsorption

Cyanide is a technically-proven and cost-effective reagent used for the recovery of gold from gold-bearing ores, and is standard practice throughout the industry.

The cyclone overflow from the grinding circuit will report to a high rate thickener and then to four leach trains in parallel for leaching, each equipped with five leach tanks. The tanks will be contained in a walled concrete slab to provide secondary containment.

The ore slurry is thickened to approximately 50% solids and then passes through the following stages:

- leaching of the feed slurry in a series of leach tanks to which oxygen and sodium cyanide are added, within an alkaline environment (approximately pH 10.5) to keep the cyanide in solution; at lower pH values cyanide will start to volatilize to the atmosphere within the mill building (and could produce unsafe conditions);
- adsorption of the gold that is dissolved in cyanide solution onto activated carbon in the carbon-in-pulp (CIP) circuit which is comprised of two parallel adsorption lines, each with seven tanks containing activated carbon;
- transfer of the loaded (gold bearing) carbon from a CIP tank to the gold recovery circuit; and
- discharge slurry (tailings) from the CIP will be pumped to the pre-detoxification thickener, prior to the wastewater treatment circuit for cyanide destruction.

Most of the activated carbon used in the process will be reactivated for use in the CIP circuit. A small fraction of finer activated carbon will form an inert waste, which will be appropriately stored for subsequent disposal.

5.6.4.1 Gold Recovery

A conventional or equivalent carbon stripping and electro-winning circuit will be used to recover gold from the loaded activated carbon. The principal recovery steps include:

- desorption of the washed loaded carbon with a higher strength, pressurized hot caustic cyanide solution, to produce a high strength pregnant (gold bearing) solution;
- electrowinning gold from the pregnant solutions (CIP and gravity circuits), via electrowinning cells operating in series using steel wool cathodes to produce a gold sludge; and
- drying and smelting the electrowinning cathode sludge in an induction furnace to produce doré bars.

The gold recovery circuit will be a secure area with limited access. The electrowinning circuit has been assumed to recover 99% of gold in solution.

5.6.5 Tailings and Cyanide Use and Destruction

5.6.5.1 Tailings Geochemical Characterization

Tailings are the primary by-product from the ore processing plant. The resulting tailings, containing some residual cyanide and dissolved metals, will be directed to an in-plant cyanide destruction/precipitation circuit.

The tailings will contain all the ore materials (minus gold) as well as residual process chemicals such as cyanide and lime. Based on preliminary geochemical characterization of tailings materials produced in metallurgical testing to date (see Appendix E), the following are key findings:

- most tailings materials (97%) indicate a low potential for ARD;
- generally low concentrations of total sulphur (<0.3%) predominantly as sulphide are observed;
- the maximum reported sulphide content was 1.9%; and
- the materials exhibit a wide range in NP predominantly as carbonate (in the order of <1 to 450 kg CaCO₃/t).

5.6.5.2 Cyanide Use and Destruction

The selected cyanide destruction system is the SO₂/Air process. The SO₂/Air process is an industry standard process that destroys the cyanide, and significantly lowering concentrations of dissolved metals to below effluent criteria as a result of cyanide destruction. These metals would then precipitate in the TMF. The tailings will be directed to the TMF via a slurry pipeline.

The cyanide leaching process which will be used in the Project will be designed as per industry best practices to meet all conditions for the responsible management and use of cyanide. This

includes sodium cyanide transportation and storage, the mixing and use of the reagent in the ore processing plant and the final destruction of cyanide tailings prior to pumping it to the TMF.

Cyanide (sodium cyanide) is dissolved and added to the leach circuit at a steady rate of approximately 0.33 kg of cyanide per tonne of ore feed. During the leaching and CIP process, cyanide will occur as both free cyanide and complexed with heavy metals present in the ore. The cyanide will thus be partially consumed as it reacts with sulphur, oxygen and other metals in the ore. A pre-detoxification thickener will be installed to recycle some of the residual cyanide to the ore processing plant water system.

The tailings slurry will be subjected to in-plant SO₂/Air treatment for cyanide destruction. In-plant SO₂/Air treatment of cyanide and metallo-cyanide complexes involves the following (or equivalent) reactions:

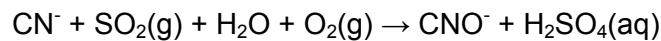

where copper is used as a catalyst to oxidize the cyanide ion (CN⁻) to the cyanate ion (CNO⁻), also producing aqueous sulphuric acid (H₂SO₄). Cyanate then reacts with water (hydrolyzes) to form ammonia (NH₃) and carbon dioxide (CO₂) in accordance with the following reaction:

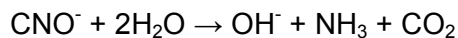

Cyanate hydrolyzation is a long-term reaction that takes place mainly in the TMF. Often, sodium metabisulphite (Na₂S₂O₅) is used in the process instead of sulphur dioxide (SO₂), but the overall reaction produces a similar result, as per the following:

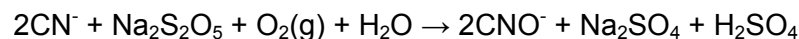

Metallo-cyanide complexes are oxidized according to the following general reaction:

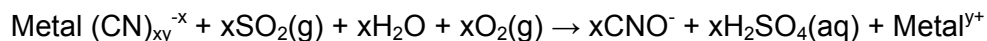

The free metal ions are then precipitated by adding lime to form insoluble metal hydroxides, which subsequently become adsorbed onto tailings particle solids, forming less reactive and more environmentally friendly compounds, and will be settled out of the slurry in the TMF. The cyanide destruction will occur in destruction tanks located in a concrete containment area outside the ore processing plant building.

The concentration of cyanide from the SO₂/Air treatment for cyanide destruction is expected to be approximately 2 ppm total cyanide.

5.6.6 Other Reagent Use

The primary chemicals to be used and stored at the Côté Gold Project site are typical of those used in Ontario and other gold mines: fuels (diesel, propane gas and gasoline), and process-related chemicals and reagents. A list of anticipated reagent use is detailed in Section 5.13 (see Table 5-1).

Several of these reagents will be used in the ore processing plant and for wastewater treatment. If equivalent alternative and/or more eco-friendly reagents for those listed are available, they may be considered for use if it proves to be cost efficient.

Consumption rates are approximate and based on test work and best management and operating practices. All process reagents will be stored according to supplier and safety guidance, as discussed in Section 5.13.

5.7 Tailings Management Facility

Tailings deposition and storage is a key component for the operations and long-term closure strategy for the Project. The treated tailings discharged from the ore processing plant will be pumped to the TMF for settling and retention, located north of the open pit, for permanent storage (see Figure 1-2).

Alternative locations for the development of the TMF were assessed by Knight Piésold (2013), and are described in Chapter 7. The TMF site selection process was carried out in accordance with Environment Canada's Guidelines for the Assessment of Alternatives for Mine Waste Disposal (Environment Canada, 2011), and the principal criteria for selection of the TMF arrangement and site were the following:

- select a technically and economically feasible alternative and location;
- use natural topography for containment to minimize the construction of dams;
- provide for all tailings storage in a single location;
- position the TMF in a manner such that drainage from the system can be collected and managed in an integrated manner, in accordance with MMER and Provincial environmental approval requirements;
- provide for an optimal operations and closure scenario;
- minimize potential adverse effects to aquatic and terrestrial habitats, including SAR; and
- consider existing land tenure and existing/potential land uses.

The selected TMF location, located approximately 4.5 km north of the proposed open pit, covers an area of approximately 840 ha (8.4 km²). The site has a moderate natural bowl feature with the highest point on the east embankment, and shallow overburden over bedrock which is exposed in some areas. The TMF will be situated over a portion of the Bagsverd Creek, which

will be realigned to reconnect with Bagsverd Lake and Unnamed Lake #2 (see Section 5.10.7 for more details).

The TMF will provide capacity for the storage of approximately 261 Mt (193 Mm³) of tailings solids over the expected Project life, with potential for expansion should additional mineral resources be delineated during ongoing exploration. Tailings, in addition to the information described in Section 5.6.5, are assumed to be non-plastic (not flexible or cohesive, more breakable), non-acid generating and it is further assumed that they will not leach metals at problematic levels. Designs are supported by geotechnical investigations of sub-surface conditions conducted in 2013 by Golder Associates.

The TMF dams will cover approximately 90% of the TMF perimeter, and will be designed as water retaining structures. The TMF will be contained by constructed rock-fill embankment dams, with the exception of small portions where the TMF will be bounded by naturally occurring bedrock.

The TMF dams will be classified using both the Canadian Dam Association (CDA) Dam Safety Guidelines (2007) and the Ontario Ministry of Natural Resources (MNR) Classification and Inflow Design Flood Criteria (MNR, 2011a). A total of six dams are proposed around the TMF. The following criteria will be used in the geotechnical design of the dam slopes:

- the Project site has a low to moderate seismic risk, with a 0.02 g horizontal peak ground acceleration for a 1,000 year return earthquake, and 0.04 g for a 100 year return earthquake;
- required minimum Factor of Safety values for the design slopes:
 - short-term, end of construction Factor of Safety = 1.3,
 - long-term, end of construction Factor of Safety = 1.5, and
 - pseudo-static loading Factor of Safety = >1.0.

Starter dams will be constructed with a geomembrane liner protected by a non-woven geotextile cushion layer to minimize seepage losses. Geomembranes will also be installed along the upstream face and areas where ponds are to be maintained within the TMF. The final dam designs will include appropriate filter and toe drains for water management and long-term dam stability, and a rock outer dam face for erosion protection. Tailings dams will be constructed mainly with mine rock from the open pit development, and augmented by some crushed rock and/or borrow material from existing and proposed aggregate pits (see Section 5.9).

Prior to development of the TMF dams, topsoil as needed will be stripped from the TMF area. This topsoil may be used in construction of the channel realignments or be stockpiled around the TMF footprint where appropriate in low height, small stockpiles, to be used for future closure activities. The TMF dams are also being designed for the most severe flood and earthquake criteria according to the Ontario *Lakes and Rivers Improvement Act* requirements.

As per industry standard, the TMF dams will be constructed in stages. Organic and unsuitable material will be stripped from the area, and starter dams will be constructed using the site topography up to approximately 389 masl in height along the north side (maximum 14 m above the ground surface), and 382 masl along the south side (maximum 2 m above the ground surface). The dams will be sequentially raised during operations over the Project life; upstream slopes will be approximately 2H:1V and embankment height to a maximum range of 40 m to 45 m and a maximum elevation of approximately 421 masl. Subsequent construction stages may use beached tailings as a low permeability layer if feasible. TMF dam designs are subject to ongoing engineering design and optimization (Golder, 2013).

Treated tailings will be pumped from the ore processing plant to the TMF through an approximately 3.5 km long, double-walled, high density polyethylene (HDPE) tailings delivery pipeline for permanent storage. In the event of an emergency or extended power outage, emergency retention ponds may be located along the pipeline length to temporarily flush the slurry from the pipeline. Tailings will be spigotted from the crest of the embankment and sub-aerially deposited, from south to north to form a gently sloping beach. This deposition technique requires scheduled rotation of the points of active deposition over a tailings beach to achieve a laminated deposit of thin layers. This enhances separation of liquids from solids and produces a clear supernatant pond that can be maintained at a reduced volume. The deposition arrangement will force runoff and supernatant to collect at the east side of the facility, forming the TMF pond. The TMF pond is discussed on further detail in Section 5.10.4 and 5.10.6.1. In general, the majority of the rock analysed to date from the open pit area (92%) is not acid-generating and it is expected that the tailings will be non-acid generating; however, further testing is currently ongoing to better characterize the acid generating potential of the ore and the processed tailings. The TMF will have a final volume capacity of approximately 193 Mm³.

Ditching and seepage collection ponds will be established around the TMF to capture runoff and seepage to be directed to back into the TMF pond. Water management for the TMF is further discussed in Section 5.10.4.

5.8 Access

5.8.1 Off site Access

The Project site is currently accessed from Highway 144 to the east via the Mesomikenda Lake access road, where the current IAMGOLD accommodation facilities and exploration office are located. Access to Côte Lake area and the existing Chester 1 mine infrastructure is through the recently installed 80 t capacity bridge over the lake via a network of light vehicle roads.

IAMGOLD intends on using the Sultan Industrial road to the south of Côte Lake as the dedicated main access point to the Project. Currently, IAMGOLD shares the use of the “Chester Access Road”, a logging road, with EACOM Timber Corporation under a Memorandum of Understanding. EACOM owns the rights to the “Chester Access Road”, and it is classified as a Primary Road under the Forest Management Plan. The road will likely remain under the management of EACOM, and be re-routed around the Project site. At present, this road is in

suitable condition and would not require any foreseeable upgrades to alignment or water crossings due to the fact that it is an active haul road.

5.8.2 On site Access

Internal haul and service roads, under the management of IAMGOLD, will link the main Project facilities and will also be linked to the existing local road network. Large haul truck roads and dedicated light vehicle access roads will be kept separate to facilitate mining operations and increase internal road safety. Only one crossing will feature in the internal road layout between the main north-south access road, between the MRA and low-grade ore stockpile, and the access road between the open pit and emulsion plant, which is shown in the site plan (see Figure 1-2).

On-site roads will have nominal travel widths of a minimum of 8 m for light vehicle roads and 32 m for haul roads. Internal ramp widths in the open pit will measure approximately 20 m to 35 m in width, sufficient to accommodate one or two-way heavy equipment haul trucks and vehicles. The ramp gradient will be approximately 8% on straight sections.

Site access to the TMF will be by means of a road which will follow the tailings (slurry) pipeline, for the most part, from the proposed ore processing plant location north towards the TMF.

5.9 Aggregates

Most of the construction materials for the Project will be NAG mine rock and overburden waste from developing the open pit. It is estimated that approximately 40 Mt of mine rock will be re-used in site construction.

Additional aggregate materials, such as sand and gravel, will be required for specialized uses including tailings dam filters, concrete manufacturing and road construction. There are currently two aggregate pits (designated as Category 9 – Aggregate Pit on Crown Land, “Pit above Water” - under the *Aggregate Resources Act*) permitted within the Project site, and these are shown in Figure 1-2. The resources remaining at these aggregate pits have been verified and contain approximately 500,000 m³. As additional tailings dam lifts will be required during the mine life, it is anticipated that the mine will provide NAG mine rock for tailings dam construction as well as providing additional haul road aggregate during the winter or high rainfall months.

5.10 Water and Drainage Management

The principal water requirements and flows at the site that will require management include:

- potable water for consumption and staff washing/showers (the mine dry);
- water for the ore processing plant (start-up and operations);
- water for truck wash facility, sanitary uses and select ore processing plant uses;
- treated water for dust control;

- mine water from the open pit (i.e., groundwater seepage and direct precipitation);
- water associated with the treated (SO₂/air) tailings effluent, as well as precipitation collected within the TMF;
- overburden seepage from pit perimeter ditch;
- runoff collected at the MRA and low-grade ore stockpiles;
- treated domestic sewage water;
- water from truck wash bays and other minor sources; and
- general site area runoff and seepage.

The area and Project site are surrounded by numerous water bodies, including lakes and rivers. The hydrology in the vicinity of the Project is described in Chapter 6 (see Figure 6-4 and 6-5). The proposed water management system for the operations phase is shown in Figure 5-2.

5.10.1 General Approach

Water management for the Project will be integrated to the extent practicable to:

- maximize the rate of water reclaim/recycle to the ore processing plant;
- select a final effluent discharge point and the total quantity of effluent discharged; and
- provide for optimal effluent quality so as to not adversely affect downstream and receiving water systems.

5.10.2 Water Supply for Ore Processing Plant Operations

The primary water reservoir to support the ore processing plant start-up will be the mine water pond which is located adjacent to the low-grade ore stockpile and the ore processing plant. Construction of the mine water pond is planned to start once regulatory approvals are obtained. For the initial start-up, water will be taken from Mesomikenda Lake and stored in the mine water pond for future use, in addition to natural inflows.

The mine water pond will be supplied by water from runoff (drainage) and seepage collection from the open pit, low-grade ore stockpile, MRA, and from general site runoff and seepage collection systems. Mesomikenda Lake is also expected to provide a potential source of make-up water for use in the ore processing plant, as needed. This uptake would not exceed 20% of the daily flow, and would occur seasonally when sufficient flow is available.

The water recycled from the TMF pond through the reclaim pipeline is proposed to minimize freshwater uptake needs. The TMF pond will receive approximately 35,000 m³/d of supernatant water. Additional water may be reclaimed from the polishing pond.

Approximately 60% to 100% of the process water may be derived from the open pit, runoff and seepage collection and supernatant water stored in both the mine water pond and the TMF pond. Under typical, average annual operations, it is expected that 48,800 m³/d of recycled water will be derived from the mine water pond and from the TMF pond, and 7,200 m³/d of freshwater from the Mesomikenda Lake (total ore processing plant water demand of 56,000 m³/d). Enough water will be stored in both the mine water pond and the TMF pond to supply the ore processing plant with water during the winter months or during potential prolonged summer/fall drought conditions. The ore processing plant water discharge to the TMF is estimated to be approximately 2,335 m³/h, with the tailings slurry, and 43 m³/h of water will be lost to evaporation from the ore processing plant.

The mine water pond will be designed to have a storage capacity of 0.59 Mm³. The mine water pond will store water with suspended solids and possibly low levels of dissolved metals, as well as residual ammonia from the use of explosives.

5.10.3 Fresh Water and Other Water Requirements

A small amount of fresh water will be used for specialized ore processing plant functions.

Potable water for domestic consumption will be provided by groundwater wells in the vicinity of the Project site for drinking water and domestic use (e.g., kitchen, showers). It is estimated that an extra 245 m³/d of freshwater will be required to meet potable water needs for the ore processing plant and accommodations complex. Approximately 552 m³/d of freshwater will also be required for the truck wash and other similar uses. Outlying areas will be provided with a bottled potable water supply.

Fresh water will also be required for the truck wash facility, which will be located next to the ore processing plant. Ditching around the truck wash will capture flowing water and runoff, which will be directed to the mine water pond.

Other water needs, either from freshwater or from the mine water pond, are expected to include:

- water supply for construction phase activities, including concrete manufacture;
- dust control on site roads and stockpiles (approximately 3,290 m³/d estimated from the mine water pond); and
- sanitary purposes (sewage).

5.10.4 Tailings Management Facility Water Management

As previously noted, current indications, based on geochemical analyses or rock samples from the proposed open pit, suggest that the majority of tailings will be non-acid generating. Tailings are currently being investigated in more detail to determine their acid generating potential. In addition, open pit, ore processing plant site runoff and MRA water management is expected to be integrated with TMF operations. The tailings slurry from the ore processing plant will contain

residual cyanide compounds and ammonia (either as a product of cyanidation, or from open pit water reclaimed for use in the ore processing plant). Cyanide is proposed to be treated within the ore processing plant using the SO_2 /Air process.

The treated tailings slurry from the ore processing plant will be discharged to the TMF via the tailings slurry pipeline (approximately 4.5 km in length, double-walled high-density polyethylene (HDPE)), where effluent associated with this slurry will be subject to further treatment through natural degradation within the TMF. Due to the natural topography, effluent water separating out through natural degradation within the TMF will accumulate in the eastern part of the TMF, forming the TMF pond (see Section 5.10.6.1). This water will be used to form part of the process water requirement for the ore processing plant. Tailings solids are settled and residual chemicals in the water column are passively precipitated, oxidized, taken up through biological processes and/or volatilized to the atmosphere. The tailings will settle for permanent storage of the barren ore solids along with a quantity of water permanently stored within the tailings pore spaces, together with temporary storage of the remaining water portion (supernatant) in the TMF pond for future re-use.

Natural degradation is the removal of contaminants contained in retained water through complementary natural processes, providing an appropriate amount of retention time to allow the reactions to occur. These processes are most effective in warm weather conditions as biophysical activity is optimal, and natural sunlight enhances several natural degradation processes.

Cyanide and metallo-cyanide complexes are inherently unstable. Natural temperature changes and ultraviolet light from the sun break residual cyanide and metallo-cyanide complexes down to simpler, less toxic, more stable compounds. This happens primarily by volatilization of hydrogen cyanide gas to the atmosphere at extremely low concentrations, where it further reacts with oxygen and hydroxyl radicals in the air in the presence of sunlight to form carbon monoxide and nitrous oxide (Lary, 2004). The metal ions left behind in the tailings react with hydroxyl ions, forming insoluble precipitates, or else they adsorb onto suspended solids. These solids settle by gravity with other tailings solids, resulting in a clear water tailings management area pond at the surface. This water is re-used as it is recycled back to the ore processing plant. Residual ammonia will also be present in the treated tailings slurry due to explosive residue on ore and in the ore processing plant treatment process. Additional ammonia is also produced from the SO_2 /Air cyanide destruction process, where cyanide is broken down to cyanate which in turn breaks down to ammonia and carbon dioxide. Ammonia is also broken down through natural degradation, given sufficient retention time. It is a food source for bacteria and algae and it also volatilizes to the atmosphere.

5.10.5 Final Effluent Quality and Discharge

Water will be discharged from the polishing pond, which is located immediately north of the TMF. The polishing pond receives surplus water from the mine water pond. There will be no direct discharge from the TMF. The polishing pond will provide sufficient retention and holding capacity to allow for water quality levels suitable for discharge in accordance with applicable

regulations (MMER SOR/2002 222 and Ontario Regulation 560/94), and the anticipated final effluent concentrations set by the MOE to protect the receiving water(s). It is expected that a receiving water assimilative capacity study will be carried out as part of the Provincial approvals process to determine acceptable receiving water effluent loadings that will not compromise receiving water aquatic life. These receiving water assimilative studies may take into account toxicity modifying agents such as water hardness, natural chelating agents, (such as dissolved organic carbon) receiving water species sensitivities, and potentially other factors. TMF seepage quality is also expected to be consistent with these effluent quality requirements.

Discharge locations were assessed in Chapter 7, considering discharge to Bagsverd Creek or to Mesomikenda Lake (see Figure 7-1). It is expected that there will be one discharge location to the downstream end of Bagsverd Creek at Neville Lake, north of the TMF, via the polishing pond. This is further discussed in Section 5.10.6.1.

5.10.6 Water Management Structures

The primary water management structures for the Project include:

- the mine water pond;
- the freshwater pipeline from Mesomikenda Lake to a tank in the ore processing plant;
- the reclaim water pipeline from the TMF pond and polishing pond to the ore processing plant;
- the tailings slurry pipeline from the ore processing plant to the TMF;
- the low-grade ore stockpile, MRA and TMF seepage collection ponds; and
- the polishing pond and discharge pipeline to the discharge location at Bagsverd Creek.

Freshwater will be taken from Mesomikenda Lake via a single-walled HDPE freshwater pipeline to a tank located in the ore processing plant. This freshwater pipeline intake will be designed to meet applicable Federal guidelines so as to prevent the impingement and entrainment of fish.

Water management ponds are detailed in the following sections. Other water management structures for the Project include the diversion dams and watercourse realignments that will be necessary to accommodate Project components, including the open pit and TMF. These are discussed in Section 5.10.7.

5.10.6.1 Preliminary Pond Designs

Mine water pond

The mine water pond will be designed to store up to 0.59 Mm³ of mine water. Mine water from the open pit sump will be pumped to the mine water pond at a rate of approximately 270 m³/h during normal operations. Water will also be pumped to the mine water pond from runoff

collection systems around the ore processing plant and site, as well as runoff and seepage collected from the open pit, low-grade ore stockpile and the MRA.

Excess water accumulating in the mine water pond will be transferred to the TMF pond via a dedicated pipeline.

Seepage Collection Ponds

Where possible, the collection ponds will be placed along or contained by natural topography. Dams/berms will be aligned in low-lying areas. Where the natural topography is not adequate, dams/berms will be designed in accordance with both CDA (2007) and MNR (2011a) guidelines similar to the TMF dams. Fifteen seepage collection ponds are proposed along the MRA perimeter, four around the low-grade ore stockpile, six around the TMF's northern and southern boundaries and two seepage collection ponds west of the polishing pond dam.

All seepage collection ponds will be designed to collect runoff and seepage from the low-grade ore stockpile, MRA and the TMF respectively. All seepage collection ponds will be designed with enough storage capacity required to allow for storage and pumping water to the mine water pond during periods of high or low flow year-round. Seepage collection ponds along the TMF and polishing pond will return water to their respective Project components.

TMF pond

The TMF pond will be formed by the deposition of tailings slurry within the TMF, as supernatant water will accumulate in the topographical low towards the central east end of the TMF. The minimum capacity of the TMF pond at each stage of deposition over the Project life will be maintained at 2.9 Mm³.

Supernatant water accumulated in the TMF pond will be pumped to the ore processing plant as part of process water recycling via a reclaim pipeline (single-walled HDPE) parallel to the tailings slurry pipeline. The TMF pond will have an emergency overflow spillway to discharge volumes exceeding its design capacity to Lake Mesomikenda. The TMF pond storage capacity allows for dead storage of water and barge operation, the maximum monthly active storage volume for a wet year, the Environmental Design Flood (EDF) and head allowance for the Inflow Design Flood (IDF).

Polishing Pond

The polishing pond, on the north end the TMF, will allow for improved effluent water quality through the process of natural degradation, whereby any remaining residual chemicals in the water column are passively precipitated, oxidized, taken up through biological processes, and/or volatilized to the atmosphere.

The polishing pond will receive pumped inflows from the mine water pond, as well as runoff from the surrounding area. The polishing dam will be constructed as per applicable standards and guidelines similarly to the TMF dam. The polishing pond will be designed with enough capacity to withstand the both the EDF and the IDF, similarly to the TMF pond.

Excess water will be discharged to the environment via the polishing pond to the Bagsverd Creek discharge location (see Figure 1-2), in compliance with applicable effluent quality criteria. If required, water may be treated prior to release to the Bagsverd Creek by means of an effluent treatment plant. In addition, the polishing pond will have an emergency overflow spillway that will discharge volumes exceeding its design capacity to Bagsverd Creek.

5.10.7 Watercourse Realignments

As part of the proposed development of the Project, several water features will be fully or partially overprinted and the proposed watercourse realignments will total approximately 7.9 km. These include Côté Lake and Beaver Pond, portions of Upper Three Ducks Lake, Clam Lake, Clam Creek, the Mollie River and Bagsverd Creek. The proposed watercourse realignments are shown in Figure 1-2.

In order to accommodate the open pit, low-grade ore stockpile and MRA, the Mollie River will be realigned to flow north from Chester Lake into Clam Lake, where it will continue northward through Little Clam Lake into West Beaver Pond and the South Arm of Bagsverd Lake and then will be redirected southeast into Weeduck Lake. From there it will flow south, back into its original watershed in Upper Three Ducks Lake. Dams will be constructed as required to manage water levels and flow directions. The realignment will raise the water level of Chester Lake, lower the level of Clam Lake and Little Clam Lake, and raise the levels of West Beaver Pond and the South Arm of Bagsverd Lake. The realignment of Chester Lake into Clam Lake will be permanent and remain in perpetuity. All other realignments around the open pit will be closed at the end of the Project life (see Section 5.16).

In order to accommodate the development of the TMF, Bagsverd Creek will be realigned to flow west of the TMF and connect to Unnamed Lake #2, where it will flow east into Unnamed Lake #1 and then back to Bagsverd Creek, as it continues flowing northward to Neville Lake. This watercourse re-alignment will be permanent and will remain in perpetuity.

These watercourse realignments have the potential to affect fish habitat and fish communities within the Mollie River and Bagsverd Creek watersheds. IAMGOLD will need to develop habitat compensation plans in support of:

- a *Fisheries Act* Authorization for the water bodies affected by the development of the Open Pit; and
- an amendment to Schedule 2 of the Metal Mining Effluent Regulation (MMER) for the water bodies to be overprinted by the development of the open pit, the low-grade ore stockpile, portions of the MRA and the TMF.

While the compensation plans are not yet finalized, design concepts have been developed. The objective of habitat compensation measures associated with the Project will be to create habitat which achieves the biotic and abiotic habitat requirements of the resident fish species (yellow perch, northern pike, walleye and whitefish) and minimizes the risk of adverse effects to the environment (i.e., flooding and erosion). The goal will be to compensate the productive capacity and lost habitat on a “like for like” basis to maintain the fish communities within, and the functionality of, the existing habitat. Therefore, the general approach will be to design habitat to meet the current life history requirements of the resident fish. Consideration with respect to spawning, juvenile, adult foraging and over wintering habitat will be incorporated into the compensation design as appropriate. The compensation plans will consider not only the physical habitat requirements (i.e., flow, depth, fish passage, cover, and substrate), but also the biological requirements (e.g. food). Key design considerations will include:

- maintenance of existing watersheds to the extent possible;
- maintenance of the existing hydrologic flow regime to the extent possible;
- minimization of temporal disruptions to the extent possible;
- promotion of connectivity within watersheds and habitats;
- use of a natural channel design approach;
- incorporation of opportunities to increase productivity of the system;
- enhancement of habitat complexity; and
- incorporation of any limiting habitat types for resident fish populations to the extent possible.

Calder Engineering Ltd., in conjunction with Minnow Environmental Inc., is developing the preliminary realignment designs and fisheries compensation plan concepts for the Project. This process involves an initial review of alternatives, detailed evaluation of habitat productive capacity, integration of watercourse realignment design and fisheries habitat compensation, development of Project phasing, contingency planning, and assessment of monitoring needs. Natural channel design techniques are being applied to mimic natural flow and flooding patterns, and incorporate shoreline and riparian vegetation. In addition, features maybe incorporated for habitat and physical diversity, and to provide refuge areas (i.e., usable area for fisheries under either low flow or winter conditions).

It is expected that the compensation plans to be implemented at the Project site will provide sufficient habitat to maintain the existing fisheries during all phases of the Project. However, if additional compensation is required, IAMGOLD will seek opportunities within the region. Such measures will be proposed undertaken in consideration of fisheries management objectives and in consultation with the Ontario MNR and Fisheries and Oceans Canada (DFO).

The following sections describe the proposed realignments in further detail.

5.10.7.1 Côté Lake

The proposed open pit is situated under Côté Lake, requiring that it be drained before pre-stripping activities advance. Drainage of Côté Lake will require the construction of multiple dams to isolate it from connected water bodies. One dam will be constructed between East Clam Lake and Clam Creek; one between Chester Lake and Clam Creek; and one between Côté Lake and Upper Three Duck Lake. Following the completion of these dams, Côté Lake may be drained.

The Côté Lake water will be drained to an appropriate receiver in the Mollie River system, which will be determined in consultation with appropriate authorities, local communities, Aboriginal groups and stakeholders. Some water may be retained to support construction activities. Fish in Côté Lake will be caught and released to an appropriate receiver in the Mollie River system as completely as possible prior to lake draining. Any remaining fish will be caught and released continuously during the draining process.

5.10.7.2 Chester Lake and Mollie River

Chester Lake naturally feeds into the Mollie River, which currently flows through the proposed MRA and open pit. In order to safely develop the open pit and reduce the volume of water requiring management in the MRA, a dam will be constructed at the mouth of the Mollie River at Chester Lake. This will effectively block the only outlet of Chester Lake. A realignment channel will be constructed between Chester Lake and Clam Lake to direct all surface water outflows. It will extend approximately 2,200 m in length to the south end of Clam Lake. The diversion will be constructed and stabilized in order to ensure continual safe passage of fish and flow before the original passage through Mollie River is closed.

The described realignment will result in increased water levels in Chester Lake.

5.10.7.3 Clam Lake

Outflows from Clam Lake, East Clam Lake, and Little Clam Lake will require realignment, as they currently flow into the proposed open pit. They will be diverted into the West Beaver Pond, followed by the south end of Bagsverd Creek located directly north of the ore processing plant site. This will be achieved by constructing a number of dams along the east side of Clam and East Clam Lakes (five dams are currently estimated). This will effectively drain Unnamed Pond, Clam Creek, and the portion of the Mollie River located within the extents of the proposed open pit. An additional dam will be located at the northern tip of Little Clam Lake to ensure that elevated water levels during storm events do not pose a threat to the ore processing plant site. In the event of potential flood conditions, monitoring will be conducted to ensure sufficient time to evacuate workers.

A realignment channel between Little Clam Lake and West Beaver Pond will be required in order to divert water to West Beaver Pond, followed by Bagsverd Creek. The proposed realignment will pass through similar terrain to that of the existing watercourses and is expected to provide like-for-like fish habitat replacement. The realignment will be constructed and

stabilized in order to ensure continual safe passage of fish and to provide suitable flow capacity. Its proposed route is approximately 395 m in length. A second realignment, with an approximate length of 90 m, will connect Clam Lake and Little Clam Lake.

Following the completion of dam and realignment construction, the water levels of Little Clam Lake, East Clam Lake, and Clam Lake are expected to decrease. This will result in a smaller footprint. However the footprint of West Beaver Pond (towards Bagsverd Lake) is expected to increase.

5.10.7.4 Three Duck Lakes

Following the realignments described in the sections above, surface waters will flow east from West Beaver Pond through the southern arm of Bagsverd Lake. Three Duck Lakes will no longer receive flow from Côté Lake. In order to maintain water flow through the Mollie River watershed, a channel will be constructed to connect Bagsverd Lake's southern arm to the Weeduck Lake. The realignment will be approximately 750 m in length. Another channel, with a length of 90 m will be required to connect Weeduck Lake and Upper Three Ducks Lake. Both realignments will be constructed to ensure that the safe passage of fish is maintained.

A dam separating the southern arm of Bagsverd Lake from the main body of Bagsverd Lake will be required to ensure flow through the realignment. This is identified as a loss of recharge to Bagsverd Lake. In order to contain water in the southern arm of Bagsverd Lake after this realignment, an additional dam may be required along the northern border of the southern arm of Bagsverd Lake.

Appreciable changes to the water levels of Weeduck Lake and Three Duck Lakes due to this realignment are not anticipated, though Bagsverd Pond, situated at the proposed realignment between the southern arm of Bagsverd Lake and Weeduck Lake, is expected to increase in volume and footprint.

5.10.7.5 Bagsverd Lake

As described in Section 5.10.7.4, the Bagsverd Creek watershed will experience a loss of recharge from the portion of Bagsverd Creek located directly north of the ore processing plant site.

In addition, the TMF will overprint approximately 5,400 m of Bagsverd Creek, isolating Bagsverd Lake from the northern stretch of Bagsverd Creek. In order to maintain the connection, a realignment of Bagsverd Creek will be constructed between Bagsverd Lake and Unnamed Lake #2. This will be approximately 4,300 m in length. It will pass through terrain very similar to that of the existing Bagsverd Creek which will be overprinted by the TMF, and is expected to provide like-for-like fish.

5.11 Other Facilities and Infrastructure

Other facilities and related infrastructure will be built to support the Project mining activities. These are outlined for on-site and off-site facilities and infrastructure.

5.11.1 On-Site Facilities

The following buildings and yard areas are currently planned for the Project:

- primary crusher, screen, secondary crusher and run-of-mine stockpile, with associated conveying system;
- ore processing plant;
- maintenance garage, warehouse and administration complex;
- accommodations complex, to be used for both construction and operations phases;
- fuel and lube bay;
- general laydown areas and temporary storage facilities during construction; and
- explosives manufacturing (emulsion plant) and storage facilities.

These facilities will be supported by related transport, piping and power infrastructure as needed. Engineering designs are ongoing and the final location of buildings and related infrastructure may be modified to meet the needs of the Project, within the Project property boundaries, unless otherwise planned and/or negotiated.

As shown in Figure 1-2, the location of the ore processing, maintenance and administrative complexes are proposed in one centralized area northwest of the open pit, positioned far enough away from the open pit perimeter to protect workers and facilities from any potential blast (fly) rock. The overall layout has been developed to ensure efficient operating conditions with the least travel distances between the facilities, particularly with respect to ore and mine rock haulage and tailings pumping. Special attention will be given to the separation of large haul truck traffic and other site (or local) vehicular traffic during the construction and operations phases.

The ore processing plant building will house the milling, gravity separation, carbon-in-pulp, reagent, carbon stripping, electro-winning and refining areas, as well as the tailings pumps and compressors. The tailing thickeners, leach tanks, lime slaking and cyanide destruction areas are anticipated to be located outside of the ore processing plant. Adequate equipment and handling procedures will ensure that cyanide and other reagents are stored and used safely, as is standard for Ontario gold mines.

The maintenance garage, warehouse and administration complex will be positioned near to the ore processing plant. It is expected that some temporary general laydown areas will be required during the construction phase, particularly near the ore processing plant site. Materials and

equipment will be kept in the general laydown areas near the ore processing plant site in order to minimize transport distances to expedite construction efforts. It is possible that some material for tailings dam construction will need to be stockpiled for short periods of time. It is planned to place these small and temporary stockpiles within the future TMF footprint, so as to avoid additional clearing.

Working bays will allow indoor maintenance on heavy equipment and smaller vehicles. Wash bay(s) will be present for trucks and other equipment to be washed and to allow for effective maintenance and to extend equipment life. Truck wash water will be treated prior to discharge to the environment to meet regulatory requirements, if required. The chemicals stored and details on their storage, handling and transportation are detailed in Section 5.13.

It is expected that approximately 1,500 construction workers may be accommodated during the construction phase. Construction accommodation for this workforce will be developed on site, and will include sleeping quarters, as well as a dining room, kitchen, recreation facilities and utility rooms. It is currently foreseen that the accommodation complex will be located a few hundred meters west of the ore processing plant to allow for easy transfer of staff from the accommodation complex to the construction areas. For the operations phase, the accommodation complex will be converted to hold a workforce of approximately 500 full-time personnel. The location may vary slightly as engineering progresses on the Project.

Explosives needed for the Project will be prepared in a dedicated explosive manufacturing facility or emulsion plant. It is currently foreseen that this facility will be tentatively located towards the east area of the property, at a safe distance from the open pit and mine infrastructure. The distances between the various buildings that make up the facility (ammonium nitrate storage, emulsion plant, explosives magazines) and other facilities and roads will be established in accordance with the Quantity Distance Principles User's Manual (Natural Resources Canada, 1995). It is not expected that explosives can be reasonably transported to the Côte Gold Project site from an off-site facility; however, that alternative will be retained should such a commercial operation be developed locally.

5.11.2 Off-Site Facilities

Non-hazardous solid waste management alternatives were assessed in Chapter 7 (see Figure 7-1). At this stage, it is planned that Project waste will be disposed of by using the existing MNR Neville Township Landfill, approximately 2 km from the Project site (see Figure 1-2). The landfill will continue to be owned by MNR and its use to dispose of wastes produced at the Project will be managed through contractual agreements. Closure of the landfill would be under the care and maintenance of MNR. MNR is currently conducting a capacity study on the existing landfill to see if it will meet Project requirements and the future requirements of the existing local residences.

No other Project facilities are proposed off site, with the possible exception of leasing offices and storage space in nearby cities or towns to support hiring or other administrative activities. IAMGOLD currently has offices in Toronto.

The transmission line is considered an off-site component of the Project, and is discussed in the following section.

5.12 Transmission Line and Power Supply

Initial construction and site preparation power will be provided by the existing connection to the Provincial electrical grid, supported by diesel power generator(s), as required. It is currently expected that temporary diesel power generation, of less than 5 MW, may be required during the construction phase. This system would then be utilized as a back-up emergency source in the event of an electrical power failure once the Project enters the operations phase.

Power during the operations phase of the Project will be supplied by a new 230 kV transmission line connected to the existing Hydro One Network in Timmins at the Porcupine Substation. The proposed TLA alternatives are shown in Figure 5-1. Two TLA alternatives were considered, and are discussed in Chapter 7. The Cross-Country TLA was selected as the preferred TLA. It is the shorter of the two TLA alternatives considered to the Project site, reducing the amount of land that needs to be cleared to create the ROW.

The Cross-Country TLA consists of three segments, totalling a length of 120 km. The first section will begin at the Porcupine Substation and will run parallel to the existing Hydro One 115 kV transmission line for approximately 46 km. This section travels in the south-southwest direction towards Sudbury. It will then cross the southern-most end of the Mattagami Dam and travel in the southwest direction, closer to Highway 144 and Gogama for approximately 68 km. For the final section of approximately 6 km, the transmission line will travel west towards the Project site. The construction of this TLA will require the clearing of approximately 675 ha of land to create the TLA ROW and to expand the existing ROW along the first section of the TLA.

The proposed TLA is mainly composed of wood portal frame structures. However at some locations, steel towers will be used for line or river crossings. The wood frame structures will be H-frame portals with pole heights ranging from approximately 21 m to 24 m. Dead-end structures will be guyed. Depending on soil conditions, rock excavation may be required to set poles to the required depth for stability. The steel towers will be rigid lattices with triangular phasing configuration. The structures will require either an overburden or rock foundation depending on existing landscape conditions.

The transmission line will use the following conductor and ground cables:

- Single circuit, three-phase conductor, 26/7 Aluminum Conductor Steel-reinforced, 795 MCM (“Drake”);
- Optical ground wire, 24 fibres, 14 mm nominal diameter;

- Overhead ground wire, Alumoweld 9.8 mm diameter; and
- Counterpoise wire American Wire Gauge #4.

Electrical clearance for conductors will be in conjunction with C22.3 N°1 of the Canadian Standards Association. Detailed clearance will be confirmed as engineering designs progress. A continuous counterpoise for line grounding is planned for the entire length of the transmission line. Perimetric counterpoises are also planned around the wood structures.

The ROW for the new sections of the proposed TLA will be 50 m wide, with approximately 25 m on each side. Where the transmission line runs parallel to existing lines, the width of the ROW will be 45 m, with approximately 20 m on the side of the existing line's ROW. This assumes an average tree height of 20 m at maturity.

Access to the ROW will be via existing roads if possible. However, due to the landscape and relatively remote location of the transmission line, new access roads will be constructed as necessary, as well as a road within the new line's ROW for the entire length of the line for maintenance purposes. The existing roads, located in the existing Hydro One ROW, have not been taken into account since we are not aware of permissions given from Hydro One.

5.13 Fuel and Chemical Management

The chemicals to be used and stored at the Project site are: process-related chemicals and reagents, fuels (diesel, propane gas and gasoline), and equipment maintenance materials (oil, grease, lubricants and coolants). Table 5-1 provides an overview of the expected storage requirements for the reagents at the Project site. All chemicals will be transported, stored and handled in accordance with applicable regulations and good management practice. Tanks will be installed with appropriate secondary containment, and protected against potential vehicular collisions if appropriate. Incompatible materials will be stored separately and not in close proximity to the warehouse or other areas.

Most of the fuel required at the Project site will be diesel needed to operate the heavy equipment fleet. A fuel station will be established adjacent to the truck shop, for easy access by heavy equipment such as haul trucks. The fuel station will have a diesel fuel pump station for mining vehicles and a containerized lube top-off system for oil, grease, windshield washing fluid and coolants. Fuel will be stored in 15 diesel tanks of 50,000 L each, for a total storage of 750,000 L of diesel at the Project site. Other vehicle maintenance liquids will be stored in double-walled tanks or equivalent.

A small quantity of gasoline will also be stored in a double-walled Enviro tank at the Project site for use by light vehicles, all-terrain vehicles, snowmobiles, boats and gas-powered tools, along with propane. Propane may be required at the Project site for use in equipment and potentially for heating. Any storage of pressurized gases will be in accordance with applicable regulations.

Alternatively for gasoline storage, a dual compartment diesel and gasoline tank could be used, rather than a dedicated gasoline tank.

All liquid fuel transfer areas, where there is a reasonable potential for spills, will be constructed to contain fuel that might inadvertently be spilled. Automatic shut-off valves and other such equipment as dictated by best practice will be installed to further reduce the risk of spills during fuel transfer operations. Oil/water separators will be installed in such locations to manage runoff.

Equipment maintenance materials, such as engine oil, hydraulic oil, transmission fluid, gear oils and greases, will be stored in secured containers within the maintenance shop or warehouse. Lubricants will also be securely stored for use at the ore processing plant.

Various solvents, other cleaners and antifreeze will also be required for equipment and vehicle maintenance. These materials will be stored in secured containers within the maintenance garage and protected area of the warehouses. Solvents and cleaners will also be securely stored for use at the ore processing plant.

Table 5-1: Anticipated Reagent Use and Handling

Reagent	Use	Delivery (anticipated)	Storage / Handling
Lime (CaO)	pH adjustment; mix into a hydrated lime slurry in ore processing plant	Fine powder in contained trucks	Silo; handled in accordance with industry standards for the protection of worker safety and the environment.
Oxygen (O ₂)	Required in leach circuit	Bulk liquid in tanker trucks; expected to be replaced by onsite oxygen plant	Stored in a pressurized holding vessel; handled in accordance with industry standards for the protection of worker safety and the environment.
Sulphur dioxide (SO ₂)	Cyanide destruction circuit	Liquid in 26 t tanker trucks; or solid (sodium metabisulphite)	Stored in a pressurized holding vessel; handled in accordance with industry standards for the protection of worker safety and the environment; or bulk bags stored with secondary containment; handled in accordance with industry standards for the protection of worker safety and the environment.

Reagent	Use	Delivery (anticipated)	Storage / Handling
Sodium cyanide (NaCN)	Dissolution of gold; mixed with water and caustic soda to form a leach solution (NaCN use of approximately 8,600 t/yr, as comparable with other similarly sized Ontario projects)	Solid (briquettes) in containers carried by licensed carriers (preferred); or liquid in tanker trucks, if solid briquettes are not available.	Stored in containers inside a warehouse and handled in accordance with industry standards for the protection of worker safety and the environment; or diluted in a tank, stored in holding tank(s) and handled in accordance with industry standards for the protection of worker safety and the environment.
Caustic soda (NaOH)	For cyanide mixing, carbon neutralization / stripping and electrowinning; diluted prior to use	Liquid in tanker trucks	Diluted in a tank and stored in holding tank(s); handled in accordance with industry standards for the protection of worker safety and the environment.
Flocculant(s)	Slurry thickening (various); mixed into solution as appropriate	Solid, bulk super bags	Bulk bags stored with secondary containment outdoors; handled in accordance with industry standards for the protection of worker safety and the environment.
Copper sulphate (CuSO ₄)	Catalyst to aid in the cyanide destruction process; mixed with fresh water into solution	Solid, bulk super bags	Bulk bags stored with secondary containment; handled in accordance with industry standards for the protection of worker safety and the environment.
Nitric acid (HNO ₃) (or similar)	Acid washing of loaded carbon; diluted prior to use	Liquid in tanker trucks	Stored in a holding tank; handled in accordance with industry standards for the protection of worker safety and the environment.
Activated carbon	Adsorption of gold in solution	Solid, Bulk super bags	Bulk bags stored outdoors; inert material handled for dust control.

* Based on test work, supplier recommendations and practices in existing plants — as currently anticipated; may be altered depending on availability and other aspects.

Other minor reagents may include antiscalants, Leachaid and standard industry fluxes, typically consisting of borax, silica and nitre for use in the induction furnace.

Source: IAMGOLD (2013).

5.14 Domestic and Industrial Waste Management

Domestic wastes produced at the Project site are likely to include: food scraps, refuse, clothing, metal tins, scrap metal, glass, plastic, wood and paper. IAMGOLD has started a recycling program and will expand and accommodate waste management for the Project.

Non-hazardous wastes produced during the Project operations phase, and possibly also during the construction of the Project, will be landfilled on site or trucked off site to a licensed landfill. A burn area may be established at the Project site subject to environmental approvals for

seasonal open air burning of clean wood packaging and similar materials that are not returned to the vendor or reused, to help preserve landfill capacity.

Alternatives for landfill development are assessed in Chapter 7. The preferred alternative is to transport non-hazardous solid wastes to a nearby off-site landfill, the MNR/Chester Township Landfill (approximately 2 km from the Project site). This existing landfill is managed and operated by the MNR, and has an estimated capacity of 43,000 m³, which will not be sufficient to meet the Project needs. IAMGOLD may acquire permits to use the landfill, though it would need to be expanded by the MNR in order to meet estimated waste production needs over the life of the Project. This agreement will also accommodate local residences around Mesomikenda Lake to continue to use the MNR Neville Township Landfill.

An estimated total of 41,680 m³ of waste is expected to be produced throughout the life of the Project – approximately 31,680 m³ during construction and operations, and 10,000 m³ during closure. Non-hazardous demolition wastes related to closure of the Project are expected to be stored in a dedicated demolition waste landfill upon closure.

It is important to note that the waste projection estimates assume that no recycling efforts are undertaken, and are therefore considered to be very conservative, as IAMGOLD does intend to pursue recycling efforts, which will result in waste diversion.

Waste oil and lubricants will be stored in double-walled or equivalent tanks or sealed containers in bermed areas, and periodically removed for off-site disposal at licensed facilities using licensed haulers. Spent solvents and cleaners will also be stored in sealed containers and periodically removed for off-site disposal at a licensed facility using appropriately licensed haulers. Waste antifreeze will be similarly stored on site, until a licensed transportation company can safely remove it for off-site disposal.

If required, a bioremediation area could be developed for bioremediation of hydrocarbon contaminated soils rather than transporting these materials offsite. This need will be assessed during future engineering investigations.

5.14.1 Atmospheric Emissions

5.14.1.1 Air Emissions

Air emissions from the Project site will derive from point sources and fugitive sources, with fugitive sources likely to contribute the majority of the air emissions. The primary point source air emissions are expected to be suspended particulate (dust) from the conveyors and crusher(s). Measures will be taken to minimize dust creation at the ore processing plant site and to utilize dust collection devices where practical. Primary crushing is expected to take place in a partially enclosed structure to provide shelter and to reduce dust escaping into the environment. Additional dust control will be installed if required.

Fugitive dust will be released from: drilling and blasting operations (within the pit); loading and off-loading of overburden, mine rock and ore; vehicle and heavy equipment travel on gravel roads; and from wind entrainment from stockpiles and other exposed earth materials. Water and other Provincially-approved dust suppressants will be used, as appropriate, to control fugitive dust emissions (an estimated 3,290 m³/d of water from the mine water pond will be used for dust control purposes throughout the Project site). Additionally, the speed of the vehicles travelling along the site roads will be limited.

Construction phase diesel power generation, and vehicle and heavy equipment use during all Project phases, will release particulates, sulphur dioxide, and nitrogen oxides from the combustion of fuel. Construction vehicles and diesel generators will require maintenance and will need to be equipped with factory-installed emission control devices to minimize emissions. Nitrogen gases, carbon dioxide and other trace gases will also be released from explosives usage.

Air quality modelling was carried out to ensure that effects on air quality are fully considered during engineering design (see Appendix F).

5.14.1.2 Greenhouse Gas Emissions

GHG emissions will derive principally from diesel fuel combustion during heavy equipment operation, and with diesel-fired power generation during the Project construction phase.

During the construction and operations phases, transmission line grid power will be used to meet the majority of Project stationary equipment power demands, thereby reducing potential GHG emissions at the site. GHG emissions associated with other fuel sources, such as gasoline and propane, are expected to be minor. In addition, there will be indirect GHG emissions, as removed trees will no longer store/sequester CO₂, which will be compensated by replanting for carbon neutrality. The use of electrically powered mining trucks and shovels may also be investigated in an effort to reduce the production of GHGs and to reduce operating expenses. Anticipated GHG emissions for the Project have been assessed as part of air quality studies to ensure that effects on air quality are fully considered during engineering design (see Appendix F).

5.14.1.3 Noise Emissions

The principal anthropogenic noise sources at the Project site are expected to derive from open air, heavy equipment operation, such as that associated with the extraction and handling of overburden, ore and mine rock. Ore processing plant site operations, including crushing and grinding, will be partially enclosed, and associated noise emissions are expected to be minor. During the Project construction phase, there will be additional heavy equipment operation, as well as diesel generators that will temporarily contribute to overall noise emissions.

Noise source modelling was carried out to ensure that noise and noise-related effects are fully considered during engineering design (see Appendix G). The assessment of noise and vibration considers noise and vibration effects to surrounding sensitive receptors, and considers Ministry of Environment noise and vibration guidelines. Taking proposed mitigation measures into account, equipment selection and operations schedules around hauling materials, the Project will generate noise from operations at most receptors that are at, or below the current ambient noise level.

5.14.2 Domestic Sewage

Domestic sewage treatment alternatives were assessed in Chapter 7. Domestic sewage during the construction and operations phase will be treated by an appropriately-sized package sewage treatment plant (e.g., sequencing bioreactor, rotating biological contactor, membrane bioreactor, or equivalent), depending on the location and the volume of sewage requiring treatment. Effluent meeting regulatory requirements will be discharged directly to the environment. The location(s) of the facility(ies) has not yet been defined, but generally will be located in proximity to the primary domestic sewage source(s). The remaining sludge will either be trucked off-site to a licensed landfill or potentially be disposed of in the TMF.

5.14.3 Solid Wastes

Solid mineral wastes expected to be produced by the Côté Gold Project include overburden, mine rock and tailings. Overburden and mine rock will be re-used as practical and reasonable for construction purposes, and otherwise stored in surface stockpiles. Overburden is expected to be utilized during closure. Further detail is provided in Section 5.6. Tailings management is discussed in Section 5.8.

Special management solid wastes at the site are expected to include: waste petroleum products and packaging, waste glycol, petroleum contaminated soil, waste explosives and possibly biomedical waste. All special management wastes will be stored in sealed containers in lined, bermed areas (or in other means of secondary containment as appropriate).

Off-specification petroleum products (and potentially waste oil) may be used as fuel for the diesel generator(s) or heat generation, or transported off site. The quantities of used lubricating oils and other lubricants created on site will be minimized to the extent practical. Used glycol, lubricants and associated materials will be stored in tanks with secondary containment and shipped off site by a licensed disposal company. Opportunities to recycle some of the hazardous waste, such as used oil, will be investigated.

Small quantities of other used fluids, such as cleaning solvents and degreasing agents, will be classified by type and either treated on site, if appropriate, or stored and transported off site to licensed processing facilities in accordance with applicable regulations and best management practices.

Although every reasonable effort will be made to reduce the potential for spills to the environment, it is recognized that minor spills associated with heavy equipment usage (dominantly petroleum hydrocarbons and glycol) may occur occasionally. Contaminated overburden and other materials, associated with any such spills, will be excavated and treated in an on-site remediation area, or transported off site to a licensed facility for disposal, as appropriate. For emergency and spill response procedures, see Chapter 13.

Explosive wastes will be destroyed according to an approved methodology by the explosives contractor or licensed personnel.

Only very small quantities of biomedical waste are likely to be created on the site associated with first aid. Biomedical waste and other similar items, such as sharps and used needles, will be transported off site to a licensed facility for proper disposal.

5.15 Project Phases and Schedule

Every effort will be made by the proponent to streamline the Project feasibility and engineering studies, and to obtain the necessary environmental approvals, to commence some components of Project construction in the first quarter of 2015. This schedule aims for gold production at the Project starting in the first quarter of 2017, though several studies are still underway and the scheduling dates will be determined as studies and approvals are finalized. The uncertainty in timing of the environmental assessment process and approvals is understood; and it is recognized that approvals may constrain the timing of some of the activities that have been scheduled. The actual timeline for Project development will therefore depend, in part, on the timing of the Federal and Provincial EA processes and subsequent environmental approvals and then economic feasibility of the Project.

Ownership, control or access to lands and any infrastructure required to develop the Project will be timed to support construction efforts. Unless stated otherwise above, IAMGOLD will have ownership and control of all Project components and infrastructure and will be responsible for monitoring and maintaining their integrity.

The approximate durations of the key Project phases are as follows:

- Construction: 2 years;
- Operation: 15 years;
- Closure: 2 years; and
- Post-closure:
 - Stage I – 50 to 80 years
 - Stage II

Further details will be determined as the engineering studies progress during the permitting stage.

5.15.1 Construction Phase

Construction activities will be coordinated according to manpower and equipment availability, scheduling constraints and site conditions. Some activities, particularly those involving work in wet or poorly accessible terrains are best carried out under frozen ground conditions. The development of activities will also consider environmental aspects, such as fish spawning and bird nesting seasons.

Primary construction phase activities will include:

- procurement of material and equipment;
- movement of construction materials to identified laydown areas and site;
- expansion of existing environmental protection and monitoring plan(s) for construction activities;
- construction of additional site access roads;
- construction of dams and water realignment channels/ditches for the development of the open pit, as well as the construction of the TMF;
- construction/placement of “compensatory” fish habitat within channel realignment works authorized to offset the loss of lake habitat;
- dewatering of Côté Lake to allow for the pre-stripping of the open pit;
- stripping of overburden and initiation of open pit mine development;
- development of aggregate source(s) anticipated to be principally for concrete manufacture, foundation work and TMF dam filter zones;
- establishment of site area drainage works, including pipelines from freshwater / recycled water sources;
- development and installation of construction facilities including laydown, camp facilities, augmenting electrical substation capacity and other related construction infrastructure;
- construction of associated buildings and facilities, fuel bay, sewage plant and landfill (if developed);
- preparation of on-site mineral waste handling facilities, including the TMF dams; and
- construction and energizing of a 230 kV feeder transmission line including on-site electrical substation.

The accommodation complex, with a capacity to host 1,500 workers, will be constructed at the start of construction to be used during the construction and operations phases.

5.15.2 Operations Phase

During the Project operations phase, overburden, mine rock and ore will be extracted from the pit for stockpiling or, for ore, transported directly to the ore processing plant primary crusher for

sizing. Sized ore will be processed in the ore processing plant to recover the gold and produce doré bars for periodic transportation by road off site by secure means. Typically, for a project of comparable size, the final product is shipped off by truck once per week.

As the operations phase continues, the open pit will become progressively deeper, and related overburden and mine rock stockpiles, as well as the TMF, will become larger and higher.

Solid and liquid wastes/effluent will be managed to ensure regulatory compliance. Environment-related activities that will be carried out during the operations phase are anticipated to include:

- ongoing management of chemicals and wastes;
- water management/treatment;
- air quality and noise management;
- environmental monitoring and reporting;
- follow up environmental studies; and
- progressive site reclamation, where practical.

5.15.3 Decommissioning/Closure Phase

Rehabilitation of the Project site is expected to take approximately two years to substantially complete and will commence once operations have ceased. The site will continue to be cared for and maintained while the open pit floods. Monitoring activities will be carried out during this period.

Conventional methods of closure are expected to be employed at the Project site. Following closure, and in order to meet regulatory requirements, some components will be progressively closed out and reclaimed during the post-closure stages. The conceptual closure plan is briefly described in the following sections.

5.16 Conceptual Closure and Reclamation Plan

Closure of the Project site will be governed by the Ontario *Mining Act* and its associated Regulation and Code. The *Act* requires that a Closure Plan be filed for any mining project before it is undertaken, and that financial assurance be provided in advance of Project development to ensure that funds are in place to carry out the Closure Plan.

The primary objective of the closure phase is to rehabilitate the Project site area to as near a rehabilitated and natural state as practical. All infrastructure is to be removed (unless otherwise stipulated, based on agreements with the respective authorities and local communities) and the area is to be able to support plant, wildlife and fish communities or be considered for other land uses as applicable.

It should be noted that revegetation will be a key aspect of the rehabilitation measures. This will occur through seeding and hand-planting of seedlings of indigenous plant species, as appropriate, to initiate colonization by those plant species. Investigations may be carried out to determine if the overburden may require any enhancement to facilitate revegetation, and to evaluate the possibility of establishing specific wildlife habitats following closure.

5.16.1 Components to be Closed

A conceptual layout of the Project site at the end of operations is provided in Figure 5-3. The Project components and associated infrastructure that will require closure include:

- open pit (including related perimeter dams) and associated dewatering infrastructure;
- MRA and associated ditching, seepage collection ponds, and piping/pumping equipment;
- low-grade ore stockpile and associated seepage collection ponds;
- TMF, reclaim pond and associated seepage collection ponds;
- aggregate pits;
- ore processing plant buildings and infrastructure (including machinery);
- accommodation complex and related facilities;
- petroleum products, chemicals and explosives;
- on-site roads, pipelines and power lines;
- general site drainage and water management structures;
- watercourse realignments; and
- waste management facilities.

The Côté Gold Project will be closed and rehabilitated in three stages: closure, post-closure stage I, and post-closure stage II. In accordance with the *Mining Act*, Regulation and Code, the first closure stage will encompass the three phases of active closure: Temporary Suspension; the state of Inactivity; and Closure (with respect to site rehabilitation and infrastructure removal that would be undertaken within approximately 2 to 5 years of shutdown of operations). Post-closure stage I covers the period during which the open pit is rehabilitating (flooding), while stage II signifies the time period when the pit has flooded and most of the natural watercourse drainage patterns can be re-established. The conceptual plans for these three stages are briefly described in the following sections.

5.16.2 Closure Phase

The primary objective of the closure phase is to rehabilitate the Project site area to as near a productive and natural state as practical. All infrastructure is to be removed (unless otherwise stipulated, based on agreements with the respective authorities and local communities) and the

area able to support plant, wildlife and fish communities or will be considered for other land uses as applicable.

It should be noted that revegetation will be a key aspect of the rehabilitation measures. This will occur through seeding and hand-planting of seedlings of indigenous plant species, as appropriate, to initiate colonization of those plant species. Investigations may be carried out to determine if any enhancement to facilitate revegetation (e.g., fertilization) is required, and to evaluate the possibility of establishing specific wildlife habitats following closure.

5.16.2.1 Open Pit

It is planned that the open pit will begin filling once dewatering activities cease. Flooding will be achieved passively through natural ground water and precipitation inputs, and by actively filling the open pit using runoff pumped from the MRA and/or alternate sources (i.e., seasonal freshwater inputs from the nearby watercourses or recycled water from the TMF).

Other measures to be taken to reclaim the open pit may, or are likely, to include:

- construction of a boulder fence around the perimeter of the open pit and a barricade at the pit access ramp(s) during or following active mining operations to ensure safety while the pit is flooding;
- removal of all infrastructure and equipment within the open pit and clean up of any fuels and lubricants such as petroleum hydrocarbons from vehicles and/or mechanical equipment, if necessary;
- removal or stabilization of drainage channels and water management structures constructed for dewatering/diversion purposes;
- revegetation of the non-flooded overburden slopes within the open pit to a stable condition and to facilitate riparian habitat along the pit lake margins. Stockpiled topsoil or overburden will be used; and
- construction of a permanent overflow spillway to safely convey runoff from all flood events, including the inflow design flood, which is assumed to be the Probable Maximum Flood (PMF).

Currently, issues with regards to the flooded open pit water chemistry are not anticipated.

5.16.2.2 Mine Rock Area

Overburden stockpiled during the site construction phase, primarily from initial open pit stripping operations, will be used during the closure phase to provide the medium for revegetation of the rehabilitated site components and areas. It is expected that only a small quantity of overburden will be stripped and stockpiled from the Project area for rehabilitation in the MRA for closure activities, due to the little, to no amount of overburden occurring over the Project site (see

Sections 5.3.2.1 and 5.5.1). Stockpiled overburden will be strategically used during closure activities to achieve closure goals.

Current geochemical analyses indicate that mine rock is non-acid generating (NAG). The MRA slopes will be designed and constructed to meet closure requirements. At closure, the exterior slopes of the MRA will be graded and stabilized, if/where required, to ensure long-term stability and drainage, once the maximum height is reached. Flat surfaces of the MRA will be partially covered with a layer of overburden and partially vegetated to expedite the growth of indigenous plants and trees. It is expected that progressive rehabilitation of the MRA will be carried out during operations as the final configuration is reached to minimize the amount of rehabilitation effort required at the time of closure.

5.16.2.3 Low-Grade Ore Stockpile

IAMGOLD proposes to process all stockpiled low-grade ROM ore during the operations phase. Thus, reclamation of these stockpiles is not expected. If necessary, any residual stockpiled ore will be stabilized in the same fashion as the MRA.

5.16.2.4 Tailings Management Facility

The closure concept for the TMF has been developed to promote long-term chemical and physical stability, minimize erosion, provide long-term environmental protection, and minimize long-term maintenance requirements. Initial assessment indicates that the tailings will be NAG. Additional geochemical test work is underway to confirm the geochemical characteristics of the tailings.

At the end of the operations phase, assuming the tailings are NAG, the TMF will be drained of supernatant water (TMF pond), in accordance with discharge criteria as per established operational requirements. An overflow spillway will be constructed, with discharge to a downstream overflow discharge channel, and from there to Mesomikenda Lake. The overflow spillway through the dam section will be designed to pass the Probable Maximum Flood (PMF; the peak flow from the 24-hour probable maximum precipitation (PMP) storm). The polishing pond water will be discharged to Bagsverd Creek. The tailings beaches will then be contoured, if/as needed, to ensure that any precipitation will drain naturally and minimize erosion.

The tailings beach will be vegetated with native species. Test plots will be carried out prior to closure to determine optimum seed mixture and fertilizers required to ensure sustainable plant growth. Pending results of the test plots, other alternative measures will be taken into consideration to ensure successful sustainable vegetation. Perimeter ditches will be left in place and protected from erosion, as needed.

Runoff and seepage from the revegetated/rehabilitated TMF is expected to be suitable for release to the environment. However, it will also be monitored and, if necessary, control and

treatment measures will be implemented to ensure that the receiving streams are adequately protected.

5.16.2.5 Dewatering Infrastructure

Pumps, pipelines, sumps and associated equipment used for open pit dewatering during the operations phase will be removed from the pit and sold for re-use/recycle, or disposed of either at the on-site demolition waste landfill (see Section 5.16.13) or at external licensed facilities.

The pumps and pipelines used during the operations phase for directing water from the MRA seepage collection ponds to the mine water pond will be used to direct water from the MRA water seepage collection ponds to the open pit.

5.16.2.6 Aggregate Pits

There are currently two aggregate pits (designated as Category 9 – Aggregate Pit on Crown Land, “Pit above Water” - under the *Aggregate Resources Act*) permitted within the Project site. If a quarry or additional pits are required and developed during the construction and/or operations phases, these, as well as the already existing aggregate sources, will be progressively rehabilitated and reclaimed according to Provincial approvals and standards, which may include natural flooding to create pond features.

5.16.2.7 Removal and Disposal of Buildings and Infrastructure

A dedicated on-site demolition waste landfill is expected to be developed for the disposal of non-hazardous demolition wastes (such as concrete, steel, wall board and other inert materials) generated during closure (see Section 5.16.13). It is expected that this demolition landfill will be developed within a portion of the NAG MRA or within an approved landfill site.

Salvageable machinery, equipment and other materials will be dismantled and taken off site for sale or reuse, if economically feasible. There will be no polychlorinated biphenyl (PCB) – containing equipment used at the site. Gearboxes or other equipment, containing hydrocarbons that cannot be cleaned out, will be removed from equipment and machinery and transported off site for disposal at a licensed facility.

Above-grade concrete structures will be broken and reduced to near grade, as required. Concrete structures and affected areas will be in-filled, contoured, and covered with overburden, as needed and revegetated.

5.16.2.8 Petroleum Products, Chemicals and Explosives

All petroleum products and chemicals will ultimately be removed from the site. Empty tanks will be sold as scrap, reused off-site, or cleaned to remove any residual fuel/chemicals and deposited within the demolition landfill.

An environmental site assessment will be conducted at the end of operations or early in the closure phase to delineate areas of potential soil contamination, particularly around fuel handling areas. Soil found to exceed acceptable criteria will be remediated on site or transported off site to an approved disposal facility.

Any remaining explosives will be either detonated on site or hauled off site by an authorized transportation company.

5.16.2.9 Roads, Pipelines and Power Lines

Unless otherwise previously negotiated with the respective authorities, Aboriginal groups and local communities, site roads will be scarified, edges sloped as appropriate, and revegetated when no longer required to support final reclamation, long-term site management and/or environmental monitoring programs. Safety berms, if any, along the perimeter of haul roads will be levelled. Culverts will be removed in accordance with provincial guidelines and roads will be breached to allow natural drainage.

The Chester EACOM road is expected to remain in place following closure due to continued access of forest harvest areas within the 100 year Forest Management Plan (FMP).

There will be a number of pipelines at the site, including the tailings slurry pipeline and the reclaim water pipeline between the ore processing plant and the TMF. Buried pipelines that are not removed will be plugged and left in place or purged, if needed, dismantled and disposed of in the on-site demolition waste landfill (see Section 5.16.13).

The pumps and pipelines used during the operations phase for directing water from the MRA seepage collection ponds to the mine water pond will be used to direct water from the MRA water seepage collection ponds to the open pit.

The 230 kV transmission line will continue to operate to provide power to the pump houses and potential water treatment plants as necessary, and is expected to be closed out before or by the end of post-closure stage I (see Section 5.16.3).

The on-site 230 kV transmission lines, poles and associated equipment that have no salvage value will be dismantled and deposited in the on-site demolition landfill. Other power equipment and materials, including oil-filled transformers, will be taken off site for sale or reuse. Any contamination, should it occur, will be appropriately cleaned up.

The off-site portion of the 230 kV transmission line will be evaluated at the end of the Project for transfer to the local utility for care and maintenance and/or potential reuse. Should the transfer to the local utility prove itself not feasible it will be dismantled. Rehabilitation would include removal and recycling/reuse of electrical equipment. Poles would be removed or cut at grade, and either reused or disposed of.

5.16.2.10 Watercourse Realignment

Watercourse realignments and associated dams will be left in place during this stage.

5.16.2.11 Site Drainage and Water Structures

The general site drainage patterns will remain in place at closure, except for drainage from culverts and related ditches during site road reclamation activities.

Water intake structures constructed at the Mesomikenda Lake (or other water bodies, if any) will be removed and any mechanical components will be disposed of in the on-site demolition waste landfill.

5.16.2.12 Waste Management

Solid Wastes

At the end of reclamation activities, the on-site landfill(s) will be capped and revegetated in a manner consistent with the remainder of the Project site and environmental approval requirements.

An on-site demolition waste landfill will be constructed within a portion of the NAG MRA or within an approved landfill site exclusively for receiving non-hazardous demolition wastes related to the closure of the Project site. At the end of rehabilitation activities, the on-site demolition waste landfill will be capped and revegetated in a manner consistent with the remainder of the site and environmental approval requirements.

Domestic Sewage

The sewage treatment plant installed at the Project site will be removed and disposed of. Non-hazardous wastes will be sent to the on-site demolition waste landfill, while hazardous wastes will be removed from the site and disposed of in accordance with Provincial approvals and standards.

5.16.3 Post-Closure Stage I

Following the removal of infrastructure and waste, as well as the revegetation of disturbed areas, the open pit will continue to flood. It is anticipated that this stage could last approximately 50 to 80 years. Flooding will occur through natural groundwater infiltration and precipitation, as well as by active filling with water collected in some or all of the MRA seepage collection ponds (see Figure 5-4). If the water quality is deemed suitable for discharge to the environment, pumping from the seepage collection ponds around the MRA to the pit would cease.

Watercourse realignments and associated dams will be left in place during post-closure stage I. The 230 kV transmission line will continue to operate during this post-closure stage to provide power to the pump houses. Should further pumping be required of water from seepage

collection ponds to the open pit, the transmission line would not be removed until the end of stage II (see Section 5.16.4.4).

5.16.4 Post-Closure Stage II

Post-closure stage II is the final stage of rehabilitation of the site and commences once the open pit is completely flooded. The main objective is to reincorporate the open pit lake into the existing water systems and to return the subwatersheds to their pre-mining conditions, as much as practicable. This will be completed as shown in Figure 5-5.

5.16.4.1 Mine Rock Area

Once the open pit is fully flooded, the water quality of the MRA seepage collection ponds will be monitored. Based on current studies of the mine rock geochemistry, issues with water quality are currently not anticipated. If the water quality is deemed suitable for discharge to the environment, pumping from the seepage collection ponds around the MRA to the pit would cease. The seepage water collection ponds would be drained. Any settled solids or sediments would be sampled to identify suitability to remain in place. The pond dams would then be breached and the breached dam slopes stabilized. The area around the seepage water collection ponds would be revegetated and the water would naturally drain to the environment. The infrastructure which facilitated the pumping would be removed and appropriately disposed of and/or recycled/reused where possible, either in the demolition landfill or in an appropriate off-site location.

If the water quality of the MRA seepage collection ponds is not deemed suitable for direct discharge to the environment, pumping of the MRA seepage collection ponds water into the pit would continue and closing of the transmission line would only be carried out at the end of this stage.

5.16.4.2 Watercourse Realignments and Site Drainage

In order to restore natural flow through the Neville Lake and Mollie River subwatersheds, various dams will be removed / breached and a few realignments will be decommissioned (see Figure 5-5). Any remaining dams will be maintained and inspected to prevent dam or ditch failure.

Mollie River Subwatershed

The re-alignment channel between Little Clam Lake and West Beaver Pond will be decommissioned and regraded to direct all flows from Clam Lake, Little Clam Lake, and East Clam Lake into the open pit lake.

The dam located between East Clam Lake and the open pit lake will be removed/breached, as well as the dam between the open pit lake and Upper Three Duck Lake. This will create an

inflow and outflow for the open pit lake, integrating it into the Mollie River subwatershed. The post-closure stage II flow of water is shown in Figure 5-5.

Mesomikenda Lake Subwatershed

The Bagsverd Creek to Weeduck Lake realignment channel will be appropriately decommissioned and regraded to prevent any further connection between the south arm of Bagsverd Lake and the Mollie River subwatershed. Also, the dam at the south end of Bagsverd Lake will be removed/breached, to reconnect flows from the West Beaver Pond draining into the south arm, with the remainder of the lake. The post-closure stage II flow of water is shown in Figure 5-5.

5.16.4.3 Open Pit Lake

The open pit lake will be integrated into the Mollie River subwatershed as described above.

5.16.4.4 Transmission Line

The 230 kV transmission line will continue to operate during the post-closure phases to provide power to the pump houses and potential water treatment system as required. Once the water quality is suitable for discharge to the environment without treatment, there will no longer be a necessity to keep maintaining the transmission line and this one will be dismantled. Rehabilitation will involve removal and recycling/reuse of electrical equipment. Poles will be removed or cut at grade, and either reused or appropriately disposed of, either in the demolition landfill or in an appropriate off-site location, unless other use is negotiated with local communities and/or Aboriginal groups.

5.17 Response to Comments through Consultation for the EA

Table 5-2 lists government, Aboriginal and public comments and concerns that have been received with regards to the Project description throughout the consultation process for this EA, and the responses provided.

Table 5-2: Comments and Concerns on the Project Description

Consultation Comment	Response/How has the comment been addressed?
How much area would be affected?	The proposed Project footprint will cover approximately 2,200 ha (22 km ²) during operations when all Project components are fully developed.

Consultation Comment	Response/How has the comment been addressed?
<p>How will the stockpile rehabilitation work? Will it be one pile at a time? Are you continuously rehabilitating them?</p>	<p>It is expected that the low-grade ore stockpile will be completely removed by the time the operations phase is finalized. It is therefore not expected that the low-grade ore stockpile will require rehabilitation.</p> <p>For the MRA, its exterior slopes will be graded and stabilized, if/where required, to ensure long-term stability and drainage, once the maximum height is reached. Flat surfaces of the MRA will be partially covered with a layer of overburden and partially vegetated to expedite the growth of indigenous plants and trees. It is expected that progressive rehabilitation of the MRA will be carried out during operations as the final configuration is reached to minimize the amount of rehabilitation effort required at the time of closure.</p>
<p>Individuals identified that the mine waste rock area closest to the original camp is not acceptable to the cottagers near the landing.</p>	<p>The Project design has been modified to take into consideration comments and concerns from the cottagers. The MRA is now located southeast of the open pit, which is the location furthest away from the cottagers on Mesomikenda Lake.</p>
<p>How would the Project change if it was to run on the 115 kV line only?</p>	<p>A low-grade deposit needs a high production rate to make the Project economical and a Project powered by a 115 kV transmission line would not be feasible.</p>
<p>What are the existing roads around the TMF? Also show TMF roads during all Project phases.</p>	<p>The main existing and future access roads are shown on Figure 1-2. Additional secondary maintenance roads will be required and will be constructed to minimize the disturbance area.</p>
<p>Does the EA include worker health and safety?</p>	<p>The intent of the EA is to look at environmental and social effects of the development of the Project. Although occupational (worker) health and safety is of utmost importance, it is not within the scope of the EA. However, IAMGOLD is committed to strict protection of their workforce (see IAMGOLD's Zero Harm Policy).</p>
<p>Are there alternatives to cyanide leaching that could be used for this Project?</p>	<p>Cyanide is the only economically viable option to be used at the Project based on type of the ore body.</p>
<p>When is the decision made if IPCC will be used?</p>	<p>The decision to use IPCC will be made at the feasibility or detailed design phase of the Project.</p>

Consultation Comment	Response/How has the comment been addressed?
What is the transmission line capacity?	Power during the operations phase of the Project will be supplied by a new 230 kV transmission line connected to the existing Hydro One Network in Timmins at the Porcupine Substation. The current Project design requires approximately 120 MW. The capacity of the 230 kV transmission line will allow IAMGOLD to consider potential future expansions of the Project, alternative mining equipment and/or supporting local needs.
Will pesticides be used for transmission line clearing and maintenance?	No pesticides will be used for clearing or maintenance of the transmission line right of way. If brushing is required, it will be carried out mechanically.
Will there be an issues tracking table included in the EA report?	The EA report includes government, aboriginal and public comments and concerns, see Chapter 4 and Appendix D.

FIGURES

400000 410000 420000 430000 440000 450000 460000 470000 480000 490000 500000 510000

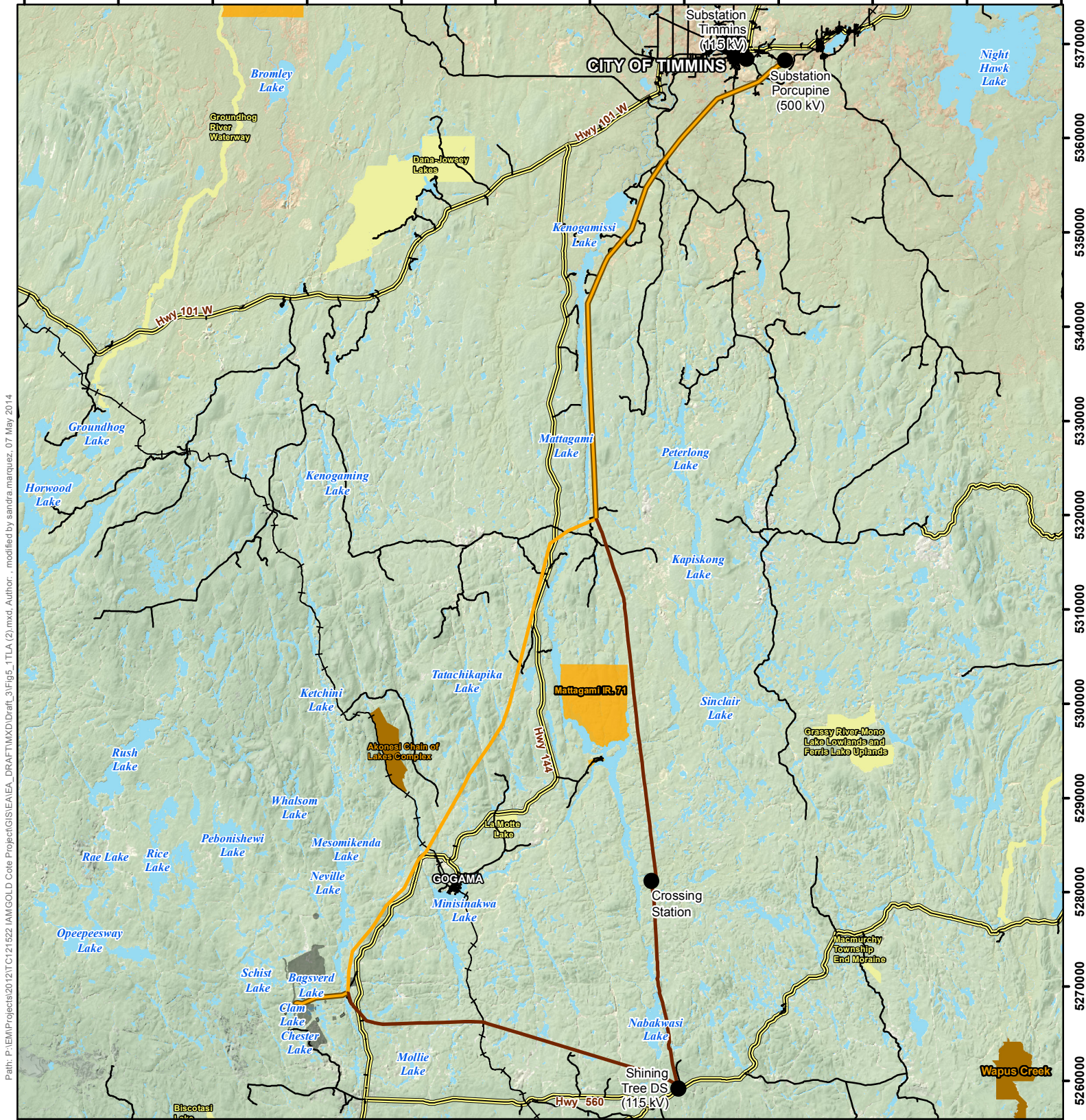

Path: P:\EM\Projects\2012\TC121522\IAMGOLD Cote Project\GIS\EA\EA_DRAFT\MXD\Draft_3\Fig5_1TLA (2).mxd, Author: , modified by sandra.marquez, 07 May 2014

5370000
5360000
5350000
5340000
5330000
5320000
5310000
5300000
5290000
5280000
5270000
5260000

LEGEND

- | | | | |
|--|---|--|----------------------------------|
| | Proposed Site Facilities | | Railway |
| | Proposed Cross-Country 230 kV Transmission Line Alignment | | Highway/Expressway |
| | Proposed Shining Tree 230 kV Transmission Line Alignment | | Local Road |
| | Waterbody / Large Watercourse | | First Nation Reserve |
| | Wooded Area | | Conservation Reserve (Regulated) |
| | | | Provincial Park |

NOTES:
 - All base data on this map was extracted from Land Information Ontario, MNDM, OBM Ontario Digital Geospatial Database and Ontario Road Network Database.



CÔTÉ GOLD PROJECT

Proposed Transmission Line Alignment Alternatives

Datum: NAD83
 Projection: UTM Zone 17N



PROJECT N°: TC121522

FIGURE: 5-1

SCALE: 1:550,000

DATE: April 2014



Path: P:\EM\Projects\2012\TC121522 IAMGOLD Cote Project\GIS\EA\EA_DRAFT\MXD\Draft_3\PropWaterManagSystem.mxd, Author: sm, modified by sandra.marquez, 19 March 2014

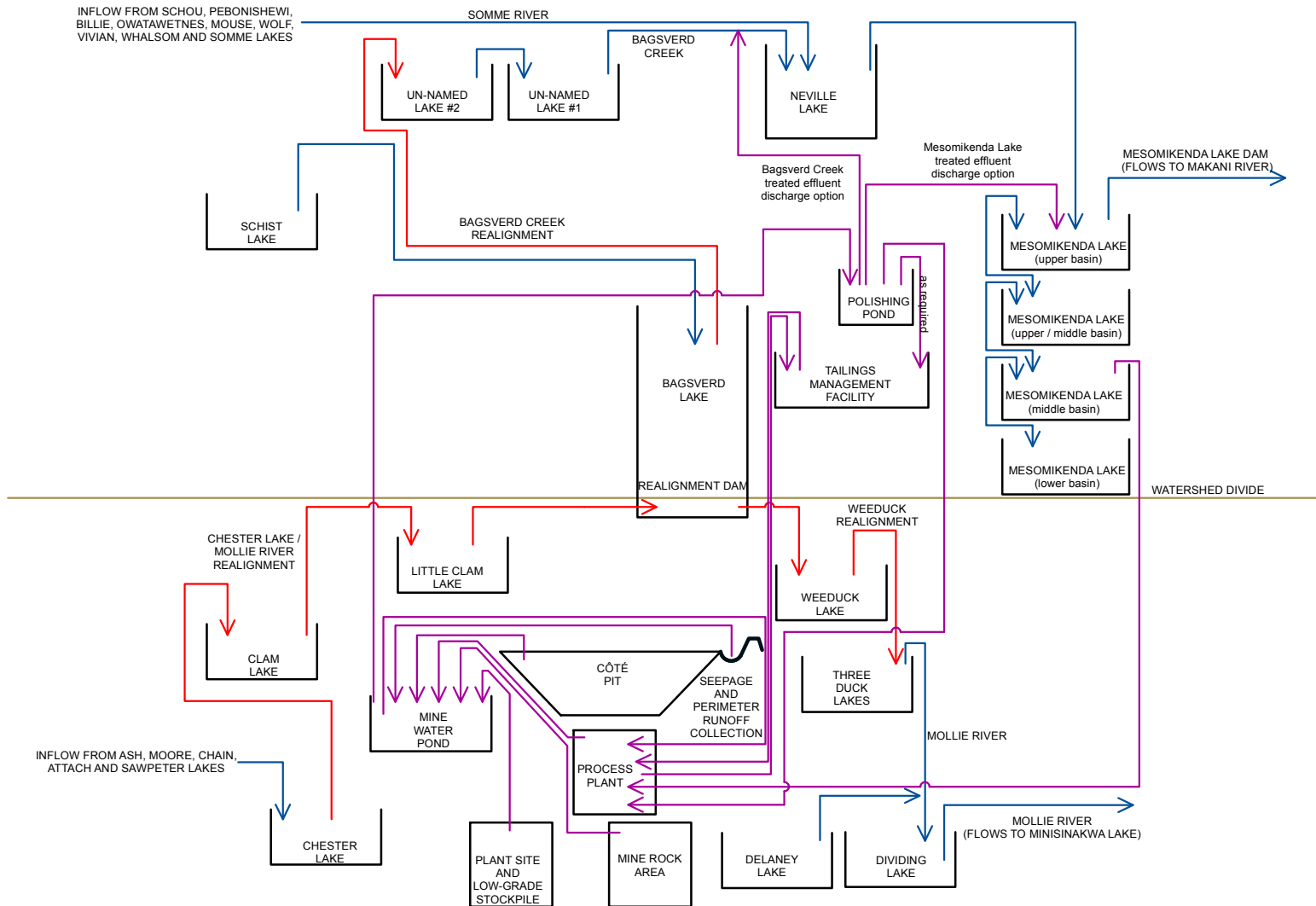

- LEGEND**
- Existing Natural Flow Direction
 - Realignment Flow Direction
 - Process Water Flow Direction

NOTES:
 - Operation's Phase Flow Schematic for Water Management.
 Source: Golder Associates, 2014



CÔTÉ GOLD PROJECT

Proposed Water Management System

Datum: NAD83
 Projection: UTM Zone 17N



PROJECT N^o: TC121522

FIGURE: 5-2

Not to Scale

DATE: April 2014

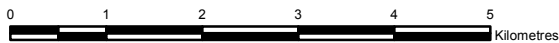

424000 426000 428000 430000 432000 434000 436000

5278000
5276000
5274000
5272000
5270000
5268000
5266000
5264000

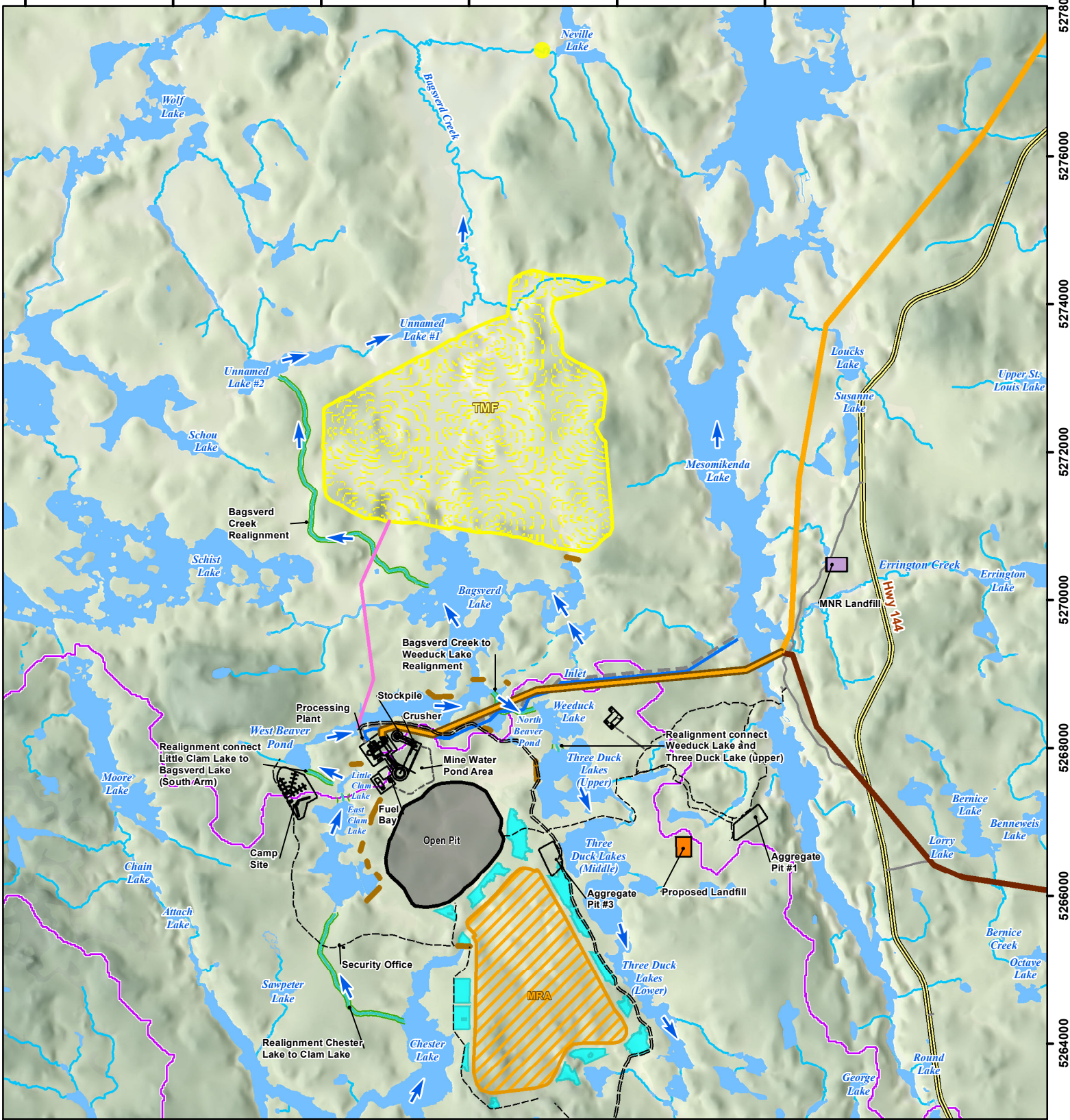

Path: P:\EM\Projects\2012\TC121522\AMGOLD\Cote Project\GIS\EA\EA_DRAFT\TXD\Draft_3\EndofOperations_2.mxd; Author: SM, modified by sandra.marquez, 08 May 2014

LEGEND		Proposed Site Features	
	Existing Intermittent Watercourse		Open Pit
	Existing Permanent Watercourse		Potential Discharge Location
	Waterbodies		Facilities
	Highway		Dam
	Local Road		Main Access Road
	Subwatershed Boundary		Access Road
	Wooded Area		Fresh Water
			Watercourse Realignment
			Proposed Water Flow Direction
			Mine Rock Area Seepage Collection Pond
			Proposed Mine Rock Area (MRA)
			Proposed Tailings Management Facility (TMF)
			Proposed Landfill
			MNR Landfill
			Cross-Country 230 kV Transmission Line Alignment
			Shining Tree 230 kV Transmission Line Alignment
			Tailings and Reclaim Pipeline

NOTES:

- Ontario base data extracted from Land Information Ontario (MNR)
- TMF and subwatershed provided by Golder Associates.
- Watercourse realignment and proposed lake area provided by Calder Engineering.
- Surface infrastructure, open pit, landfill, MRA and transmission lines provided by IAMGOLD.
- Reclaim, Water and MRA provided by Golder Associates

Datum: NAD83
Projection: UTM Zone 17N

<h2>CÔTÉ GOLD PROJECT</h2>	
<h3>End of Operations</h3>	
PROJECT N°: TC121522	FIGURE: 5-3
SCALE: 1:70,000	DATE: April 2004



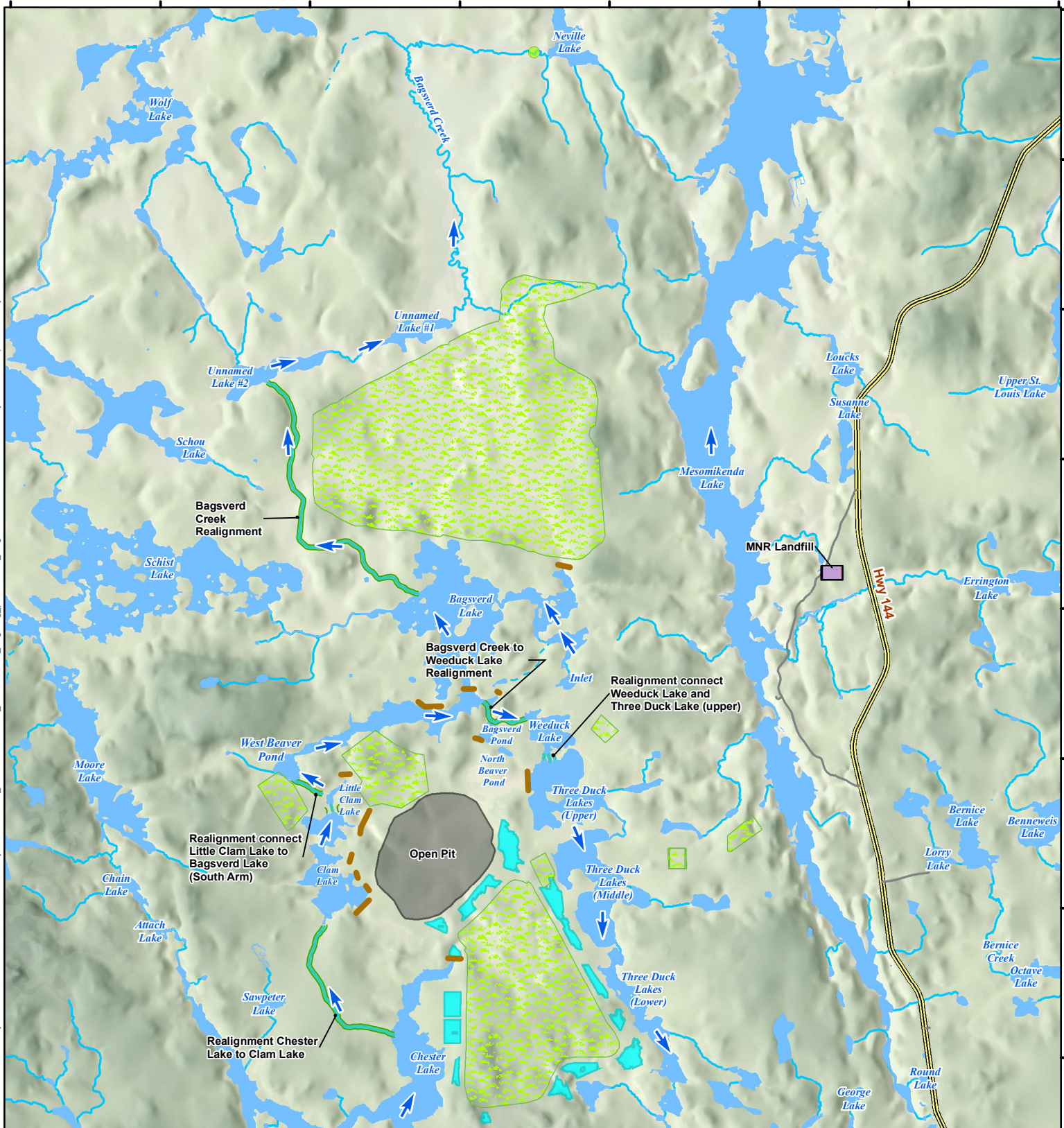

Path: P:\EM\Projects\2012\TC121522\IAMGOLD\Code\Project\GIS\EA\EA_DRAFT\MXD\Draft_3\enclosure_beginning_postclosure_stage1.mxd, Author: SM, modified by sandra.marquez, 06 May 2014

LEGEND	
	Intermittent Watercourse
	Permanent Watercourse
	Waterbodies
	Highway
	Local Road
	Wooded Area
	Proposed Water Flow Direction
	Watercourse Realignment
	Dam
	Mine Rock Area
	Seepage Collection Pond
	Revegetated Areas
	MNR Landfill

NOTES:
 - Ontario base data extracted from Land Information Ontario (MNR)
 - TMF and subwatershed provided by Golder Associates.
 - Watercourse realignment and proposed lake area provided by Calder Engineering LTD.
 - Surface infrastructure, open pit, landfill, MRA and transmission lines provided by IAMGOLD.



CÔTÉ GOLD PROJECT

End of Closure / Beginning of Post-Closure Stage I

Datum: NAD83
 Projection: UTM Zone 17N



PROJECT N°: TC121522

FIGURE: 5-4

SCALE: 1:70,000

DATE: April 2014



Path: P:\EMIP\Projects\2012\TC121522\AMGOLD\Cote Project\GIS\EA\EA_DRAFT\MXD\Draft_3\endpostclosure_stage1\beginning_postclosure_stage2.mxd, Author: SM, modified by sandra.marquez, 07 May 2014

LEGEND

Watercourse	Water Flow Direction
Waterbodies	Decommissioned Realignments
Highway	Watercourse Realignment
Local Road	Dam
Wooded Area	Mine Rock Area Rehabilitated Ponds
	Revegetated Areas
	MNR Landfill

NOTES:

- Ontario base data extracted from Land Information Ontario (MNR)
- TMF and subwatershed provided by Golder Associates.
- Watercourse realignment and proposed lake area provided by Calder Engineering LTD
- Surface infrastructure, open pit, landfill, MRA and transmission lines provided by IAMGOLD.



CÔTÉ GOLD PROJECT

End of Post-Closure Stage I / Beginning of Post-Closure Stage II

Datum: NAD83
Projection: UTM Zone 17N

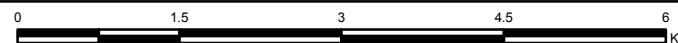

PROJECT N^o: TC121522

FIGURE: 5-5

SCALE: 1:70,000

DATE: April 2014

