

## *Appendix F2*

---

*Mitchell Pit Slope Parameter Addendum and Confirmation*

June 15, 2011

Project no. 0638-006-07

T. James Smolik  
Seabridge Gold Inc.  
108 Front Street East  
Toronto, Ontario, M5A 1E1

Dear Mr. Smolik,

**Re: KSM PFSU – Mitchell Pit Slope Parameter Addendum and Confirmation - FINAL**

Please find attached the above referenced letter report, dated June 15, 2011.

Thank you for the continued opportunity to work on this interesting and technically challenging world-class mine development project. Should you have any questions or concerns, please do not hesitate to contact the undersigned.

Yours sincerely,

**BGC ENGINEERING INC.**  
**per:**

Warren Newcomen, M.S., P.Eng., P.E.  
Senior Geotechnical Engineer

Derek Kinakin, M.Sc., P.Geo.  
Senior Engineering Geologist

## **LIMITATIONS**

BGC Engineering Inc. (BGC) prepared this document for the account of Seabridge Gold Inc. The material in it reflects the judgment of BGC staff in light of the information available to BGC at the time of document preparation. Any use which a third party makes of this document or any reliance on decisions to be based on it is the responsibility of such third parties. BGC accepts no responsibility for damages, if any, suffered by any third party as a result of decisions made or actions based on this document.

As a mutual protection to our client, the public, and ourselves, all documents and drawings are submitted for the confidential information of our client for a specific project. Authorization for any use and/or publication of this document or any data, statements, conclusions or abstracts from or regarding our documents and drawings, through any form of print or electronic media, including without limitation, posting or reproduction of same on any website, is reserved pending BGC's written approval. If this document is issued in an electronic format, an original paper copy is on file at BGC and that copy is the primary reference with precedence over any electronic copy of the document, or any extracts from our documents published by others.

## 1.0 INTRODUCTION

BGC Engineering Inc. (BGC) has been retained to provide Pre-Feasibility Study (PFS) level open pit slope design parameters for the proposed open pits for the KSM Project owned by Seabridge Gold Inc. (Seabridge). This memorandum summarizes updates to the previously provided Mitchell pit slope design parameters (BGC, 2010), provides stereonet for the updated structural model of the Mitchell pit geotechnical domains, confirms the proper application of these slope design parameters in the 2011 Pre-Feasibility Study Update (PFSU) pit design by Moose Mountain Technical Services (MMTS), and describes the depressurization requirements for the Mitchell pit slope design.

### 1.1. Previous Work

Several geotechnical studies to develop slope designs for the proposed Mitchell open pit have been completed prior to this addendum. Scoping level recommendations for pit slope design parameters were provided by Piteau Associates Ltd. (2008) and reviewed by BGC (2008). BGC provided slope design parameters for a Preliminary Economic Assessment (PEA) of the Mitchell pit (2009). These initial design parameters were based on very limited data and were considered preliminary estimates, adequate for a PEA. Following a site investigation program during the summer of 2009, BGC completed PFS level designs (BGC, 2010) to estimate slope design parameters for the Mitchell pit.

### 1.2. Structural Data Update

The PFS open pit slope design parameters were partly based on structural geology information collected via acoustic and optical televiewer surveys of the geotechnical drillholes completed during the site investigation program. The acoustic and optical televiewer probes record an image of the inside of the drillhole wall and allow geological structures to be mapped from these unwrapped 360° images (Figure 1). The dip of the structures is calculated via the shape of the sine curve defining the structure trace on the unwrapped image, where:

$$\text{dip} = \text{atan}\left(\frac{L}{D}\right) \quad (\text{Eq. 1})$$

The input parameters to Equation 1 are defined in Figure 1 below. During the processing of these data in 2009 a systematic error was introduced by the application of an incorrect drillhole diameter ( $D = 100$  mm, approximately the diameter of an HQ hole) when calculating the dip of the mapped geological structures. These data have been reprocessed and updated using the correct drillhole diameter ( $D = 75.7$  mm) for the NQ holes completed during the 2009 drilling program. As can be seen from Equation 1, reducing the drillhole diameter results in an increase in the dip angles of the structures mapped from the televiewer images. The theoretical increase in the dip angles varies from 1° to approximately

8° for this change in drillhole diameter, depending on the angle of intersection between the drillhole and geological structure. Considering this error correction, the maximum increase in the dip angle of a design geological structure set in any of the Mitchell pit geotechnical domains is 6°. Updated design stereonet for each geotechnical domain (Appendix A) and individual geotechnical drillholes (Appendix B) have been provided as part of the current memorandum. These stereonet supersede all previously provided data (BGC, 2010).

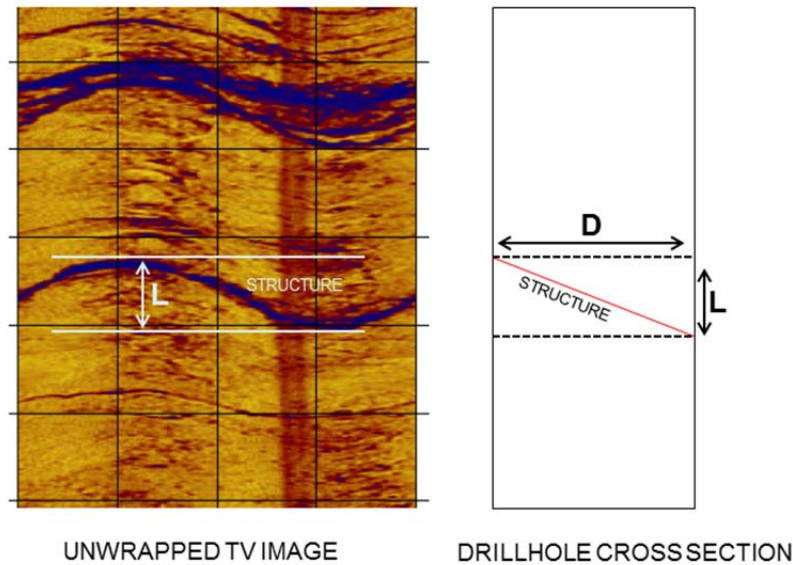

**Figure 1 Definition of parameters for Equation 1.**

### 1.3. Current Work

Slope design parameters for the Mitchell pit have been updated for the corrected structural model (Appendix A) for each geotechnical domain. In addition, the slope designs now include 20 m wide geotechnical berms every five double benches (150 m); as recommended by Mr. P. Stacey, the senior external reviewer for the open pit slope design. The ultimate open pit design by MMTS based on the provided parameters has been checked and analyzed to confirm that the PFS level geotechnical design criteria provided by BGC are satisfied.

## 2.0 PRE-FEASIBILITY STUDY UPDATE SLOPE DESIGN PARAMETERS

### 2.1. Overview

The PFS level slope design parameters for the Mitchell pit (Table 1) presented in the current memorandum supersede any previous slope design parameters provided by BGC (2010). The slope designs have been developed considering both practical mining geometries and geotechnical slope stability criteria (Table 2). The geotechnical domains and domain boundaries (Drawing 1) have not been modified from the previous study and they remain valid for use with the updated design parameters. The definitions of the various slope design

parameters are provided by Drawing 2. The design stereonet for each domain have been updated (Appendix A) and should be used in place of any previously provided data. The analysis and design methodology remains consistent with the previous PFS level work completed by BGC (BGC, 2010).

A summary of the slope design parameter changes from the previous report (BGC, 2010) for each geotechnical domain is provided below. The changes vary across the domains and design sectors; not always resulting in steeper slopes.

## **2.2. Domain I**

Domain I includes all of the slopes of the Mitchell pit below the Mitchell Thrust Fault (Drawing 1); the lower slopes and toes of the ultimate walls are within this domain. The updated interberm / interramp angles for Domain I are generally 0° to 2° steeper using the updated structural data; except for Design Sectors I-125 and I-338, where the interberm / interramp angles are 1° flatter due to the inclusion of the 150 m interberm height limit. Of particular note is Design Sector I-173, where the interberm / interramp angle has increased by 3.5° due to the updated structural model. This sector includes the lower slope of the proposed south wall of the Mitchell pit and, as a result, the change in interberm / interramp slope angle results in an increase in the overall angle of the south wall.

## **2.3. Domain II**

Domain II includes the north wall of the proposed Mitchell pit, above the Mitchell Thrust Fault and below the Sulphurets Thrust Fault (Drawing 1). The updated interberm / interramp angles for Domain II are 1° to 4° steeper with the updated structural model. The greatest change is in Design Sector II-325; however, the overall angle for the very high slope in this sector has not changed as the overall design angle is limited by rock mass stability. Additional geotechnical berms or ramps are still required in this sector to achieve the overall slope angle if the increased interberm / interramp slope angle is to be used.

## **2.4. Domain III**

Domain III includes the south wall of the proposed Mitchell pit, above the Mitchell Thrust Fault and below the Sulphurets Thrust Fault (Drawing 1). The updated interberm / interramp angles in Domain III increased 5° in Design Sector III-099, remained the same in Design Sector III-189, and decreased by 14° in Design Sector III-138. The significant decrease in Design Sector III-138, located in the south east sector of the proposed upper south wall, is due to the steepening of discontinuity set B2 in the updated structural model. Based on the previous model, this set was interpreted to be flat enough to allow it to be undercut (i.e. “daylight” in the slope) without adverse effects on the stability of the slope. The increase in the dip angle of set B2 in the updated structural model no longer allows for this set to be undercut and still meet the design factor of safety (1.2) for structurally controlled failures at the interberm / interramp slope scale. Therefore, the design slope angle in this sector must be reduced.

## **2.5. Domain IV**

Domain IV includes the slopes of the ultimate north and south walls of the proposed Mitchell pit above the Sulphurets Thrust Fault (Drawing 1). No televiewer data was collected in this domain, and as a result, the structural model has not changed. However, the updated interberm / interramp angles in Domain IV are reduced by 3° for all design sectors due to the introduction of the 150 m maximum slope height between geotechnical berms.

## **3.0 OPEN PIT DESIGN CONFIRMATION**

### **3.1. Overview**

The confirmation of an open pit design includes reviewing the geometry of the pit slopes prepared by MMTS for conformance with the slope design parameters provided by BGC (Table 1) and geotechnical stability analyses of the overall slopes of the proposed pit. The latest 3D geological models available from Seabridge (2010) have been used to develop the analysis sections (Appendix C). A minimum design factor of safety (FOS) of 1.3 against overall slope failure has been adopted for the current study. The FOS calculated by limit equilibrium – method of slices analyses for all overall slopes of the proposed ultimate Mitchell pit should meet or exceed this FOS for the open pit design by MMTS to be considered acceptable. BGC has analyzed five overall slope sections in the current work, including the north, east, west, south, and southeast walls. In addition to providing confirmation of the overall stability, the analyses have been utilized to confirm the depressurization requirements for the pit slopes (Table 3).

The analyses summarized in Appendix C pertain specifically to the overall slope scale; interramp / interberm or bench scale analyses have been described in the previous pit slope design report (BGC, 2010). The overall angle of the pit slope may be controlled by factors including: the bench configuration, the interramp slope stability, the number of ramps included in the slope design, or the stability of the overall slope. Where the estimated FOS for the overall slopes of the Mitchell pit are higher than the minimum required for geotechnical slope stability (1.3), one or a combination of the other factors previously noted is controlling the overall slope configuration. The controls on the overall slope geometry for each section analyzed are provided in Table D1.

### **3.2. Pit Slope Geometry**

BGC reviewed the Series 3 Mitchell Pit design (“Mitchell Series 3 Ultimate Pit 8Mar2011.dxf”) received from MMTS on March 9, 2011 via email. A review of the slope geometry of the pit was completed using plan maps and cross sections (Appendix C). Only one Design Sector, III-138, was identified where the interberm design angle of 34° had been exceeded. BGC communicated this required change back to MMTS on March 14, 2011. An updated pit design, “KSM Series 5 Mitchell Ultimate - M656 clp.dxf”, was received March 18, 2010. This updated design meets all of the geometric design parameters provided by BGC.

### **3.3. Overall Pit Slope Analyses**

#### **3.3.1. Analysis Methodology**

BGC has used industry standard methods to analyze the overall slope stability of the ultimate Mitchell pit. Analysis models were constructed based on the latest 3D geological model available from Seabridge and geotechnical parameters for rock mass strength previously estimated by BGC (2010). The analyses were completed with assumed water tables to identify the pore pressure conditions that must be achieved for the slopes to meet the design FOS. Through an iterative process, the slope stability requirements for depressurization were used to guide the dewatering efforts (vertical wells) simulated in the 3D hydrogeological model (BGC, 2011). Table 3 summarizes the depressurization requirements for each design sector of the ultimate Mitchell pit and the methods proposed to achieve them.

#### **3.3.2. North wall**

The ultimate north wall of the proposed Mitchell pit is the highest of all the walls in the current mine plan. It is planned to be excavated with an overall angle of approximately 45° and will exceed 1,700 m in height. The overall pit slope intersects three geotechnical domains (Drawing 1): the crest of the pit is within Domain IV, the mid-slope is in Domain II, and the lower half of the slope is within Domain I.

The pit slopes excavated in Domains II and IV push-back the existing valley wall towards the north; the slopes mined in Domain I extend the pit below the current valley floor. Less overburden is removed in Domains II and IV compared to Domain I, in mining to the ultimate wall. Therefore, the stress relief due to removal of overlying rock and reduced rock mass confinement experienced by the slopes in Domains II and IV will be less than Domain I. BGC has assumed a lower average “disturbance factor” (Hoek and Brown, 1997) for the geotechnical units of Domains II and IV (0.7) than for Domain I (0.85). The disturbance factor is used in the estimate of the rock mass shear strength for each geotechnical unit of the slope stability analysis (Appendix D) and accounts for the formation of new fractures in the rock mass from blasting near the slope face as well as stress relief outside of the blast damage zone. It is recognized that the value of the disturbance factor would be reduced from a maximum value of approximately 1 at the slope face due to blast damage and stress relief to zero at some distance into the wall from the slope face. At this stage of study and for this scale of stability analysis, it is reasonable to use an estimated average value for each geotechnical unit.

The depressurization scheme required to achieve the design FOS of 1.3 for the ultimate north wall includes vertical perimeter and in-pit wells, 300 m long horizontal drains for the slope in Domain I, and a 3.5 km long 4 m x 4 m adit with drainage galleries in Domain II (BGC, 2011).



### 3.3.3. East wall

The East wall of the proposed Mitchell pit will reach an ultimate height of approximately 650 m; the ultimate slope is excavated within Domain I. This final wall will be immediately downstream of the Mitchell Glacier water diversion structures with the intake structure of the diversion tunnel approximately 100 m east of the pit crest, based on the layout provided to BGC by KCBL on January 13, 2011.

The geotechnical design of the ultimate east slope is controlled by the potential for structurally controlled failure at the interberm or interramp slope scale (Table D1); the interramp / interberm slopes are designed to meet the FOS of 1.2 for structurally controlled failure. Depressurization of this wall will require horizontal drains to target unfavorably oriented structures and achieve a water table at least 50 m back from the pit face. This is achievable based on the current hydrogeological assessment (BGC, 2011). The FOS of the overall slope is calculated to be 2.0; the interramp scale control on the overall slope geometry does not allow the overall slope angle to be further increased.

In the case of a blockage of the Mitchell Glacier diversion tunnel during mine operations, it has been proposed that water would be diverted into the pit over the east wall. It has been estimated (KCBL, 2010) that up to 90 m<sup>3</sup>/s of water could be directed into the pit from the blocked diversion tunnel. MMTS has provided cost allowances for pumping equipment and water handling to deal with these possible flows into the pit. However, this water flow over the east slope represents a hazard to the ramps currently designed on the ultimate east wall of the Mitchell pit; erosion of the ramps by the water could reduce or eliminate access into the bottom of the Mitchell pit. In addition, if any instability of the east wall is occurring at that point in time, the release of water into the pit would likely exacerbate the problems. Therefore, this hazard requires further evaluations at the next stage of study via an assessment of the erodibility of the rock in this area of the open pit slope, and an assessment of the risk to operations should the use of the ramp in this area be compromised.

### 3.3.4. West wall

The West wall of the proposed Mitchell pit will reach an ultimate height of approximately 500 m; this final wall will be adjacent to the proposed Ore Processing Complex (OPC) and portal of the Mitchell-Tiegan Tunnels. The west wall of the Mitchell open pit will be excavated in Domain I.

The geotechnical design of the west wall is controlled by the potential for structurally controlled failure at the interramp slope scale (Table D1); the interramp / interberm slopes are designed to meet the FOS of 1.2 for structurally controlled failure. A depressurized zone 50 m from the slope face is required to target unfavorably oriented structures daylighted by this slope. This is achievable with horizontal drains based on the current hydrogeological assessment (BGC, 2011). The overall slope FOS is approximately 2.3, incorporating the depressurization needed for the interramp scale. The interramp scale control on the overall

slope geometry does not allow the overall slope angle to be increased from the current pit design. Considering the critical infrastructure located to the west of the ultimate pit crest, the relatively high FOS of the overall slope is justifiable and more than adequate.

### 3.3.5. South wall

The South wall of the proposed Mitchell pit will reach an ultimate height of approximately 1500 m; this slope height is greater than that of any existing open pit. The upper part of this wall is excavated in Domain III; while the lower slope is within Domain I. A compound slope is required, where the upper wall is steeper than the lower slope; resulting in an overall slope angle of 40°.

The geotechnical design of the south wall is controlled by the potential for structurally controlled failure along foliation in Domain I and rock mass controlled stability on the interramp / interberm slope scale in Domain III. The required depressurization for this slope is a 50 m setback of the water table from the pit face. This is achievable with vertical wells and horizontal drains (BGC, 2011). The FOS for overall slope stability based on the estimated water table is approximately 1.4. The overall slope angle cannot be further increased due to the combined slope stability controls for Domains I and III.

### 3.3.6. Southeast wall

The southeast wall of the proposed Mitchell pit will reach an ultimate height of approximately 1350 m; the lower portion of this wall will be excavated in Domain I and the upper portion is within in Domain III. The average overall slope angle for this wall is 35°. The top benches of this wall will intersect the western edge of the Snowfields landslide, a large active slope deformation in rock, which is approximately 1.5 km wide and 0.5 km high (Drawing 1). Based on preliminary assessments of the landslide, the area of greatest activity and disturbance within the landslide mass is east of and outside the ultimate open pit limits. The rock mass of the Snowfield landslide is foliated, weak, and altered as observed during field mapping completed in 2010 by BGC.

The geotechnical design of the southeast wall is controlled by the potential for structurally controlled failures in Domains I and III. The depressurization requirements for this slope include a 50 m setback of the water table from the pit face to depressurize unfavorably oriented geological structures. This is achievable using horizontal drains (BGC, 2010). The FOS of the overall slope is approximately 1.4 for rock mass controlled instability; which achieves the slope design criteria.

Slopes excavated for this wall should not be cut into the edge of the Snowfield landslide zone prior to unloading any potential landslide mass from above the working level; i.e. push-backs into the lower part of the western edge of the Snowfield landslide should not be considered; mining should progress “top-down” near the Snowfield landslide. Future investigations of the landslide and stability analyses should be conducted to determine the where the pit wall will

intersect the landslide, and to evaluate whether or not the pit slope angles should be reduced in this portion of the proposed pit.

#### **4.0 SUMMARY**

BGC has updated the PFS level open pit slope designs for the Mitchell pit of the KSM project based on an updated structural model for the geotechnical domains and additional slope design constraints recommended by the external review of the pit design. The slope depressurization requirements to achieve the pit slope designs have been summarized for the updated open pit design. In addition, BGC has provided updated design stereonet for each geotechnical domain and updated summary stereonet for each geotechnical drill hole. These data supersede previously provided information.

A design for the ultimate Mitchell open pit was completed by MMTS using the parameters provided by BGC. The Series 5 pit “KSM Series 5 Mitchell Ultimate - M656 clp.dxf” was provided to BGC on March 18, 2010 for review. BGC has confirmed the appropriate application of the slope design parameters by MMTS in the design of the provided pit. Overall slope stability analyses completed by BGC (Appendix D) for the ultimate north, south, east, and west walls of the Mitchell pit demonstrate that the minimum design factor of safety (1.3) is met for pore pressure conditions which should be achievable based on hydrogeological modeling and pit depressurization design also completed by BGC (2011). Based on the 3D groundwater model, the ultimate north slope of the Mitchell pit has been identified as requiring depressurization efforts exceeding the capabilities of vertical wells and horizontal drains to achieve the overall slope stability FOS for the current design. As a result, a dewatering adit has been included in the open pit depressurization plan to address this need (BGC, 2011).

## 5.0 CLOSURE

We trust the above satisfies your requirements at this time. We appreciate the opportunity to contribute to this world-class mine development project. Should you have any questions or comments, please do not hesitate to contact us.

Yours sincerely,

**BGC ENGINEERING INC.**  
per:

Derek Kinakin, M.Sc., P.Geo.  
Senior Engineering Geologist

M. Anne Buckingham, B.Sc.E., EIT  
Geotechnical Engineer

Reviewed by:

Warren Newcomen, M.S., P.Eng.  
Senior Geotechnical Engineer

Iain Bruce, Ph.D., P.Eng.  
Senior Geotechnical Engineer

## REFERENCES

- BGC Engineering Inc., 2011. KSM Pre-Feasibility Study Update – Pit Depressurization Study. DRAFT Report, Document no.: KSM11-10, May 20, 2011.
- BGC Engineering Inc., 2010. KSM Project – Mitchell Zone – Open Pit Slope Design. Final Report, Document no.: KSM10-01, April 16, 2010.
- BGC Engineering Inc. 2009. BGC Project Memorandum: PEA-Update Open Pit Slope Design Criteria – Mitchell Deposit, April 30, 2009.
- BGC Engineering Inc. 2008. BGC Project Memorandum: Geotechnical Comments and Recommendations – KSM Project, December 4, 2008.
- Hoek, E, and Brown, E.T. 1997. Practical estimates of rock mass strength. International Journal of Rock Mechanics and Mining Sciences, Vol 34, No 8, pp 1165-1186.
- KCBL. 2010. KSM Project: Design of Rock Storage Facilities and Water Management. DRAFT report dated December 10, 2010.
- Piteau Associates Ltd., 2008. Mitchell Project – Geotechnical Input for Project Description. Piteau Associates Ltd. # 2892.

## **TABLES**

Table 1: Mitchell Pit Double Bench Design Parameters

Domain	Design Sector	Slope Azimuth		Catch Bench Geometry			Interberm Geometry		Overall Slope Geometry		Slope Design Control
		Start (°)	End (°)	Height	Angle	Width	Height	Angle	Estimated Height Oh (m)	Angle Oa (°)	
				Bh (m)	Ba (°)	Bw (m)	l <sub>bh</sub> (m)	l <sub>ba</sub> (°)			
I	I-173	135	210	30	60	24.7	150	36	1230	36	Benchstack (B1 - P)
	I-220	210	230	30	70	25.2	150	40	1080	40	Benchstack (B1 - B3)
	I-240	230	250	30	70	15.6	150	48	660	48	Benchstack (B1 - B3)
	I-275	250	300	30	70	11.6	150	53	690	52	Benchstack (B1 - B3)
	I-338	300	015	30	70	11.6	150	53	1650	46	Rockmass stability
	I-028	015	040	30	70	11.6	150	53	1650	46	Rockmass stability
	I-078	040	115	30	70	15.6	150	48	660	48	Benchstack (A1 - B3)
	I-125	115	135	30	60	11.5	150	46	1080	45	Benchstack (Bench geometry)
II	II-325	270	020	30	70	11.5	150	53	1110	44	Rockmass stability
	II-035	020	050	30	70	17.8	150	46	690	47	Benchstack (A3-E1)
	II-058	050	065	30	70	25.2	150	40	270	42	Benchstack (A3-E1)
	II-078	065	090	30	70	31.0		36	120	41	Benchstack (A3-E1)
III	III-099	090	108	30	70	10.5	150	54	240	55	Benchstack (Bench geometry)
	III-138	108	168	30	70	34.3	150	34	480	35	Benchstack (B2-P)
	III-189	168	210	30	70	17.8	150	46	570	47	Rockmass stability
IV	IV-168	145	190	30	70	17.8	150	46	360	47	Benchstack (A1-B1)
	IV-200	190	210	30	70	26.6	150	39	360	40	Benchstack (B1-D1)
	IV-240	210	270	30	70	34.3	150	34	300	36	Benchstack (B1-D1)
	IV-003	325	040	30	70	17.8	150	46	510	47	Benchstack (F1-D1 / E1-A1)

Notes:

1. Geotechnical berms (minimum 20 m wide) must be added to the slopes every 150 m to allow for access to the slope for depressurization and monitoring.
2. No ramp allowances have been included in these slope designs; their addition will reduce the achievable overall angles.
3. Refer to Drawing 1 for geotechnical domains.
4. Refer to Drawing 2 for slope geometry definitions.

Table 2: Mitchell Pit Design Requirements

<b>Requirement</b>	<b>Value</b>	<b>Source</b>
Design factor of safety (FOS) – Discontinuity controlled stability	1.2	BGC
Design factor of safety (FOS) – Rock mass controlled stability	1.3	BGC
Single bench height	15 m	Seabridge / MMTS
Minimum catch bench width	8 m	B.C. Mines Act 6.23.2
Maximum interberm height	150 m	BGC / Review Board
Minimum geotechnical berm width	20 m	BGC / Review Board
Ramp width	32 m	Seabridge / MMTS

**BGC ENGINEERING INC.**

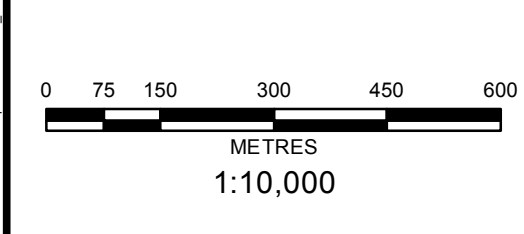
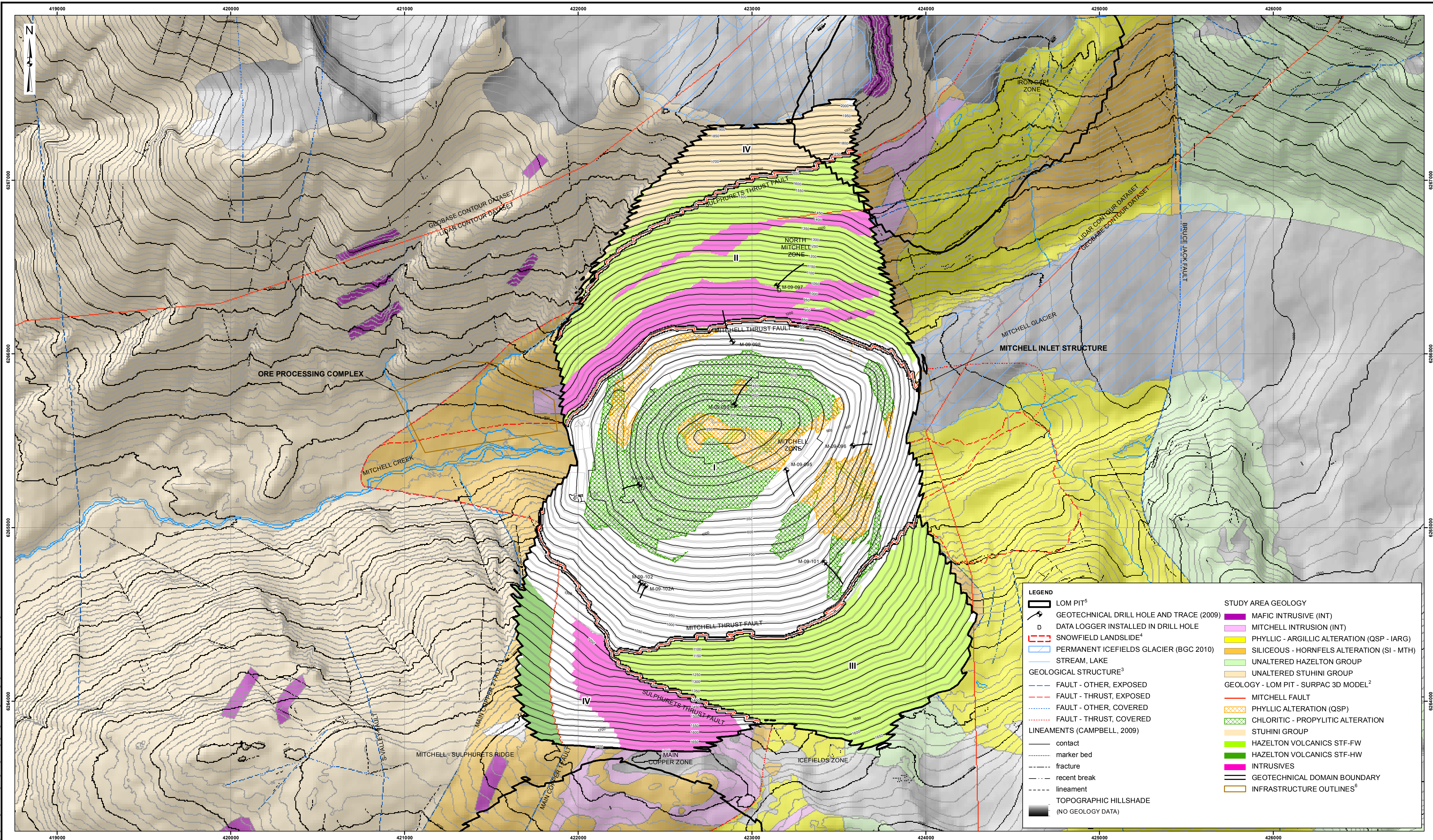

Table 3: Mitchell Pit Depressurization Requirements

Geotechnical Domain	Design Sector(s)	Description	Expected Max Slope Height (m)	Dewatering Assumption			Min Oa Horizontal Setback to WT <sup>1</sup> (m)	Pre-Mining Conditions	Unmitigated LOM Watertable	Average Horizontal Drain Length (m) <sup>2</sup>	Vertical Wells <sup>3</sup>	Other / Comments
				Bench	Interberm	Overall Slope						
I	I-173	North dipping	1230	Structures Depressurized	Structures Depressurized, Partially depressurized Rock mass	Partially Saturated (50% of potential failure mass saturated)	50	In valley bottom watertable is generally at surface, and above is a subdued replica of topography approximately 50 m bgs at the crest of the proposed pit	The unmitigated watertable essentially parallels the pit slope in this domain with little to no set-back.	150	Y	
	I-220	NE Dipping	1080				50	Watertable is at surface in the valley bottom, 100 m bgs at the crest of the proposed pit and a subdued replica of topography in between.	The unmitigated watertable essentially parallels the pit slope in this domain with little to no set-back.	150	Y	
	I-240	NE Dipping	660				50	Watertable is at surface in the valley bottom, 50 m bgs at the crest of the proposed pit and a subdued replica of topography in between.	The unmitigated watertable essentially parallels the pit slope in this domain with little to no set-back.	150	Y	
	I-275	East dipping, adjacent to OPC	690				50	Watertable is approximately at ground surface for this entire sector, approx paralleling the creek / glacier	The unmitigated watertable essentially parallels the pit slope in this domain with little to no set-back.	150	Y	
	I-338	South dipping, high wall	1650				150	Watertable is approx 75 m below ground surface at the crest of the proposed pit, at surface at the current valley bottom, and undulates between surface and 100 m bgs over the existing slope	The unmitigated watertable essentially parallels the pit slope in this domain with little to no set-back.	300	Y	A Dewatering Adit and Drainage Gallery are required to achieve the design depressurization of this slope
	I-028	South dipping, high wall	1650				150	Watertable is approx 50 bgs at the crest of the proposed pit, at surface at the current valley bottom, and undulates between those points to a max bgs depth of 100 m	The unmitigated watertable essentially parallels the pit slope in this domain with little to no set-back.	300	Y	A Dewatering Adit and Drainage Gallery are required to achieve the design depressurization of this slope
	I-078	West Dipping, adjacent to Mitchell Diversion inlet	660				50	Watertable is approximately at ground surface for this entire sector, approx paralleling the creek / glacier	The unmitigated watertable essentially parallels the pit slope in this domain with little to no set-back.	150	Y	
	I-125	NW dipping	1080				50	In valley bottom watertable is basically at surface, and above is a subdued replica of topography approximately 50 m bgs at the crest of the proposed pit	The unmitigated watertable essentially parallels the pit slope in this domain with little to no set-back.	150	Y	
II	II-325	South Dipping Upper Section of highwall	1110	Structures Depressurized	Structures Depressurized, Partially depressurized Rock mass	Partially depressurized (25% of potential failure mass saturated)	400	Watertable is approx 75 m below ground surface at the crest of the proposed pit, at surface at the current valley bottom, and undulates between surface and 100 m bgs over the existing slope	The unmitigated watertable parallels the pit slope with very little set back for approximately half of the domain, then the set back gradually increases to approximately 350 m behind the pit face	100	Y	A Dewatering Adit and Drainage Gallery are required to achieve the design depressurization of this slope
	II-035	SW Dipping	690				50	Watertable is approx 50 bgs at the crest of the proposed pit, at surface at the current valley bottom, and undulates between those points to a max bgs depth of 100 m	The unmitigated watertable parallels the pit slope with very little set back for approximately half of the domain, then the set back gradually increases to approximately 350 m behind the pit face	100	Y	
	II-058	SW Dipping	270				50	Watertable is approx 50 bgs at the crest of the proposed pit, at surface at the current valley bottom, and undulates between those points to a max bgs depth of 100 m	The unmitigated watertable parallels the pit slope with very little set back for approximately half of the domain, then the set back gradually increases to approximately 150 m behind the pit face at the height of slope	100	Y	
	II-078	SW Dipping	120				50	Watertable is approximately at ground surface for this entire sector, approx paralleling the creek / glacier	The unmitigated watertable parallels the pit slope with very little set back for approximately half of the domain, then the set back gradually increases to approximately 100 m behind the pit face at the height of slope	100	Y	
III	III-099	NW Dipping	240	Structures Depressurized	Structures Depressurized, Partially depressurized Rock mass	Partially Saturated (50% of potential failure mass saturated)	50	Subdued replica of topography the groundwater table is approx 50 m bgs	The unmitigated watertable essentially parallels the pit slope in this domain with little to no set-back.	100	Y	
	III-138	NW dipping	480				50	Subdued replica of topography the groundwater table is approx 50 m bgs	The unmitigated watertable essentially parallels the pit slope in this domain with little to no set-back.	100	Y	
	III-189	North dipping	570				50	Subdued replica of topography the groundwater table is approx 50 m bgs	The unmitigated watertable at the base of this domain is approximately at the pit face, and gradually slopes back to approx 300 m behind the pit at the height of slope.	100	Y	
IV	IV-168	North dipping	360	Structures Depressurized	Structures Depressurized, Partially depressurized Rock mass	Partially depressurized (25% of potential failure mass saturated)	50	Subdued replica of topography the groundwater table is approx 50 m bgs	The unmitigated watertable in this domain begins approximately 350 m behind the slope at the STF and slopes back into the slope to a maximum elevation of -1375 masl in the ridgetop.	100	Y	
	IV-200	NE Dipping	360				50	Watertable is at surface in the valley bottom, 100 m bgs at the crest of the proposed pit and a subdued replica of topography in between.	The unmitigated watertable in this domain begins approximately 350 m behind the slope at the STF and slopes back into the slope to a maximum elevation of -1375 masl in the ridgetop.	100	Y	
	IV-240	NE Dipping	300				50	Watertable is at surface in the valley bottom, 100 m bgs at the crest of the proposed pit and a subdued replica of topography in between.	The unmitigated watertable in this domain begins approximately 200 m behind the slope at the STF and slopes back to a set-back of 350 m at the max height of the pit slope.	100	Y	
	IV-003	Upper Section of highwall	510				600	Watertable is approx 75 m below ground surface at the crest of the proposed pit, at surface at the current valley bottom, and undulates between surface and 100 m bgs over the existing slope	The unmitigated watertable in this domain begins approximately 350 m behind the slope at the STF and slopes back into the slope to a maximum elevation of -1720 masl in the ridgetop.	100	Y	

- Notes:
1. Setback to water estimated from mid-slope of slide analyses assuming 50% of failure mass is saturated.
  2. Horizontal drain lengths have been estimated considering a 50% effective length. 100 m drains will likely be required during operations on those slopes where the LOM watertable meets bench and interberm depressurization without them (Domains II, III, and IV)
  3. Vertical wells have been modeled based on a nominal spacing, placement has not been optimized wrt pit phasing at this stage of study.

## **DRAWINGS**



NOTES:  
 1. BASE MAP AND MINE DESIGN DATASETS PROVIDED BY SEABRIDGE GOLD INC.  
 2. THE PROVIDED 3D MODEL DOES NOT INCLUDE 3D SOLIDS FOR THE ENTIRE STUDY AREA. GEOLOGY IS INFERRED FROM THE DRILLING DATA AND SURFACE MAPPING FOR THOSE AREAS.  
 3. GEOLOGICAL STRUCTURE TRACES ORIGINALLY SUPPLIED BY SEABRIDGE GOLD INC., RE-CLASSIFIED ACCORDING TO CONFIDENCE LEVEL ('EXPOSED' vs. 'COVERED') BY K. CAMPBELL, Ph.D. FOR THE CURRENT STUDY.  
 4. SNOWFIELD LANDSLIDE EXTENTS HAVE BEEN INTERPRETED BY BGC FROM FIELD OBSERVATION AND ORTHOPHOTO DATA.  
 5. SERIES 5 PITS PROVIDED BY MOOSE MOUNTAIN TECHNICAL SERVICES ON MARCH 18, 2011.  
 6. INFRASTRUCTURE OUTLINES TRACED FROM GENERAL ARRANGEMENT PROVIDED BY KBCL ON MARCH 22, 2011 (D-2001\_R).

PROFESSIONAL SEAL		SCALE:	1:10,000
DATE:		JUN 2011	
DRAWN:		WKL, MIB	
DESIGNED:		MAB	
CHECKED:		DK	
APPROVED:		HWN	

NAD 1983 UTM Zone 8N

 <b>BGC ENGINEERING INC.</b> AN APPLIED EARTH SCIENCES COMPANY	PROJECT:	KSM PROJECT PRE-FEASIBILITY STUDY UPDATE - MITCHELL PIT SLOPE PARAMETER ADDENDUM AND CONFIRMATION			
	TITLE:	GEO TECHNICAL DOMAINS			
CLIENT:	SEABRIDGE GOLD INC.	PROJECT NO.:	0638-006	DWG NO.:	01

X:\Projects\0638\006 PFS\WorkSpace\20110421\_REPORT\_KSM\_PROJECT\_PRE-FEASIBILITY\_STUDY\_UPDATE\_MITCHELL\_PIT\_SLOPE\_PARAMETER\_ADDENDUM\_AND\_CONFIRMATION02\_PIT\_SLOPE\_GEOMETRY\_PARAMETERS\_AND\_DEFINITIONS.dwg Layout: DWG 02 Plot Date: Jun 9 11 Time: 10:07 AM

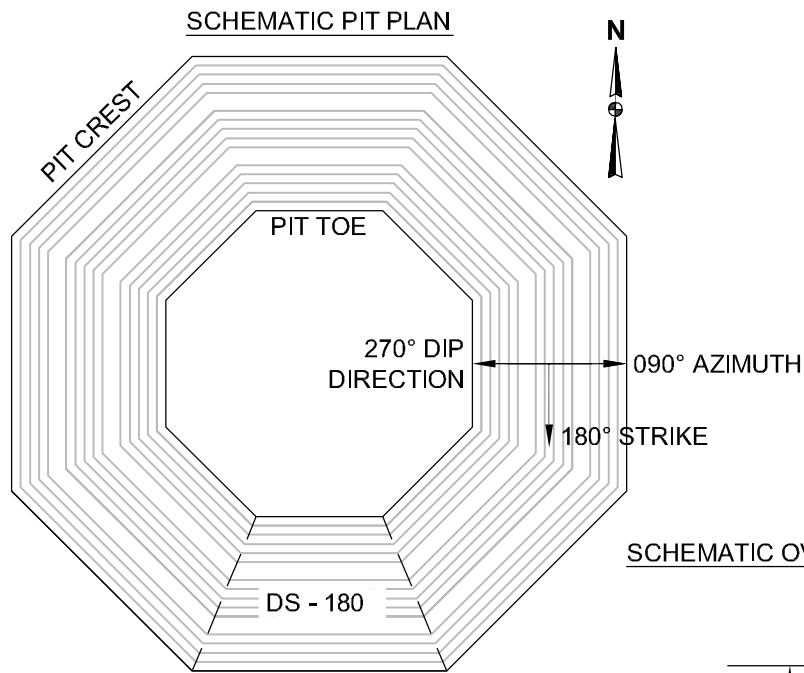

SCHEMATIC OVERALL SLOPE GEOMETRY

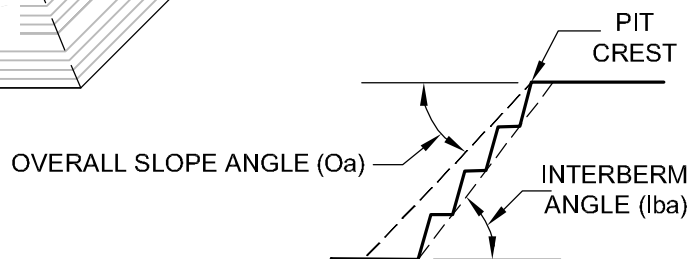

SCHEMATIC CATCH BENCH GEOMETRY

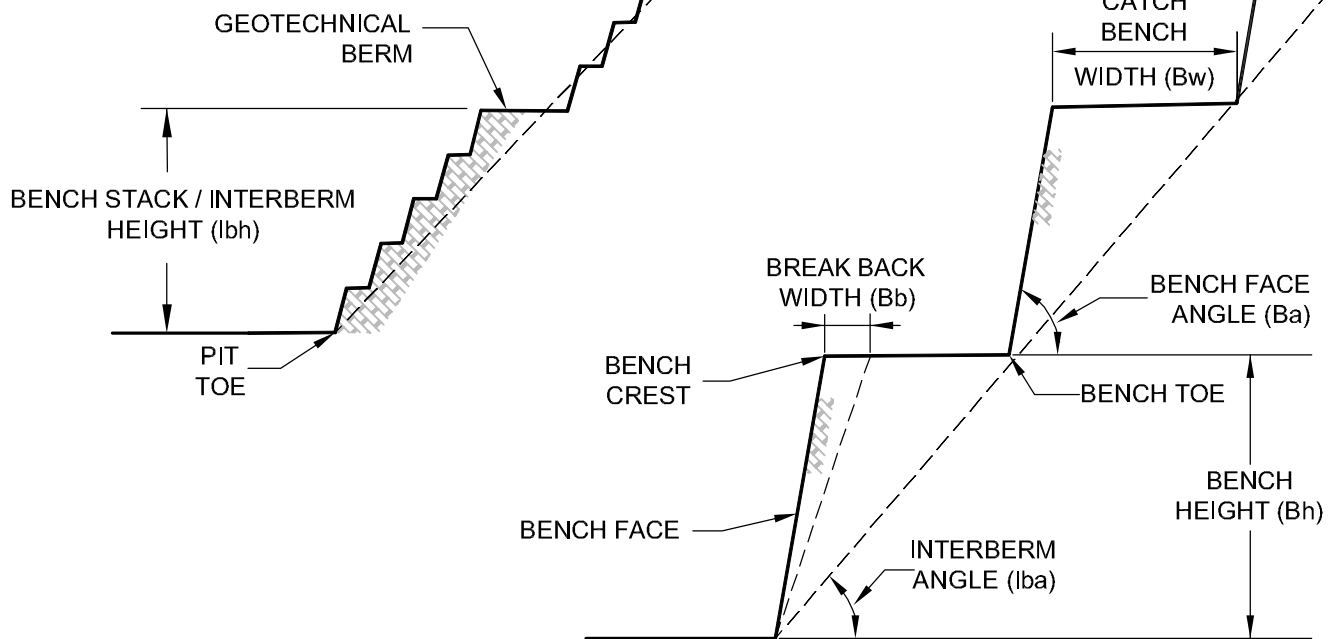

AS A MUTUAL PROTECTION TO OUR CLIENT, THE PUBLIC AND OURSELVES, ALL REPORTS AND DRAWINGS ARE SUBMITTED FOR THE CONFIDENTIAL INFORMATION OF OUR CLIENT FOR A SPECIFIC PROJECT. AUTHORIZATION FOR ANY USE AND/OR PUBLICATION OF THIS REPORT OR ANY DATA, STATEMENTS, CONCLUSIONS OR ABSTRACTS FROM OR REGARDING OUR REPORTS AND DRAWINGS, THROUGH ANY FORM OF PRINT OR ELECTRONIC MEDIA, INCLUDING WITHOUT LIMITATION, POSTING OR REPRODUCTION OF SAME ON ANY WEBSITE, IS RESERVED PENDING BGC'S WRITTEN APPROVAL. IF THIS REPORT IS ISSUED IN AN ELECTRONIC FORMAT, AN ORIGINAL PAPER COPY IS ON FILE AT BGC ENGINEERING INC. AND THAT COPY IS THE PRIMARY REFERENCE WITH PRECEDENCE OVER ANY ELECTRONIC COPY OF THE DOCUMENT, OR ANY EXTRACTS FROM OUR DOCUMENTS PUBLISHED BY OTHERS.

SCALE:	NTS	DESIGNED:	MAB
DATE:	JUN 2011	CHECKED:	DK
DRAWN:	WKL	APPROVED:	HWN



PROJECT:	KSM PROJECT PRE-FEASIBILITY STUDY UPDATE - MITCHELL PIT SLOPE PARAMETER ADDENDUM AND CONFIRMATION		
TITLE:	PIT SLOPE GEOMETRY PARAMETERS AND DEFINITIONS		

CLIENT:	SEABRIDGE GOLD INC.
---------	---------------------

PROJECT No.:	DWG No.:	REV.:
0638-006	02	

## **APPENDIX A STEREONETS BY GEOTECHNICAL DOMAIN**

## CORE HOLE AND PHOTOGRAMMETRY DISCONTINUITY DATA

Discontinuity data was collected for the PFS from both televiewer surveys of the core holes and photogrammetric mapping of the valley slopes. Additional data was available from Seabridge and MDRU geological mapping as well as BGC's 2008 PEA investigations.

The following stereonet presents the discontinuity data collected in 2009 and reprocessed in 2011 for Domains I, II, and III; Domain IV data was collected by Seabridge and MDRU through surface mapping. The data has been symbolized by structure type, as identified by field staff using the following key (Table D-1).

**Table A-1: Discontinuity Codes**

CODE	Type	Description
B	Bedding	Layering due to depositional environment, if there is separation along it call: JT-BD or FT-BD.
C	Contact	Boundary between two different rock types.
X	Cleavage	Parallel, closely spaced planar surfaces independent of bedding produced by deformation
F	Fault	Displacement evident with infill (FG)
O	Foliation	Visible alignment of grains due to temperature and/or pressure
J	Joint	Little to no displacement
S	Shear	Polished or slickensided, no infill.
V	Vein	Geological discontinuity with mineral infilling

Note:

1. The above structure types may be hyphenated to describe compound structure types, such as a fault along bedding, F-B.

Design structural sets have been chosen based on distribution and concentrations of the data, and named according to the naming convention provided.

# DISCONTINUITY SET NAMES

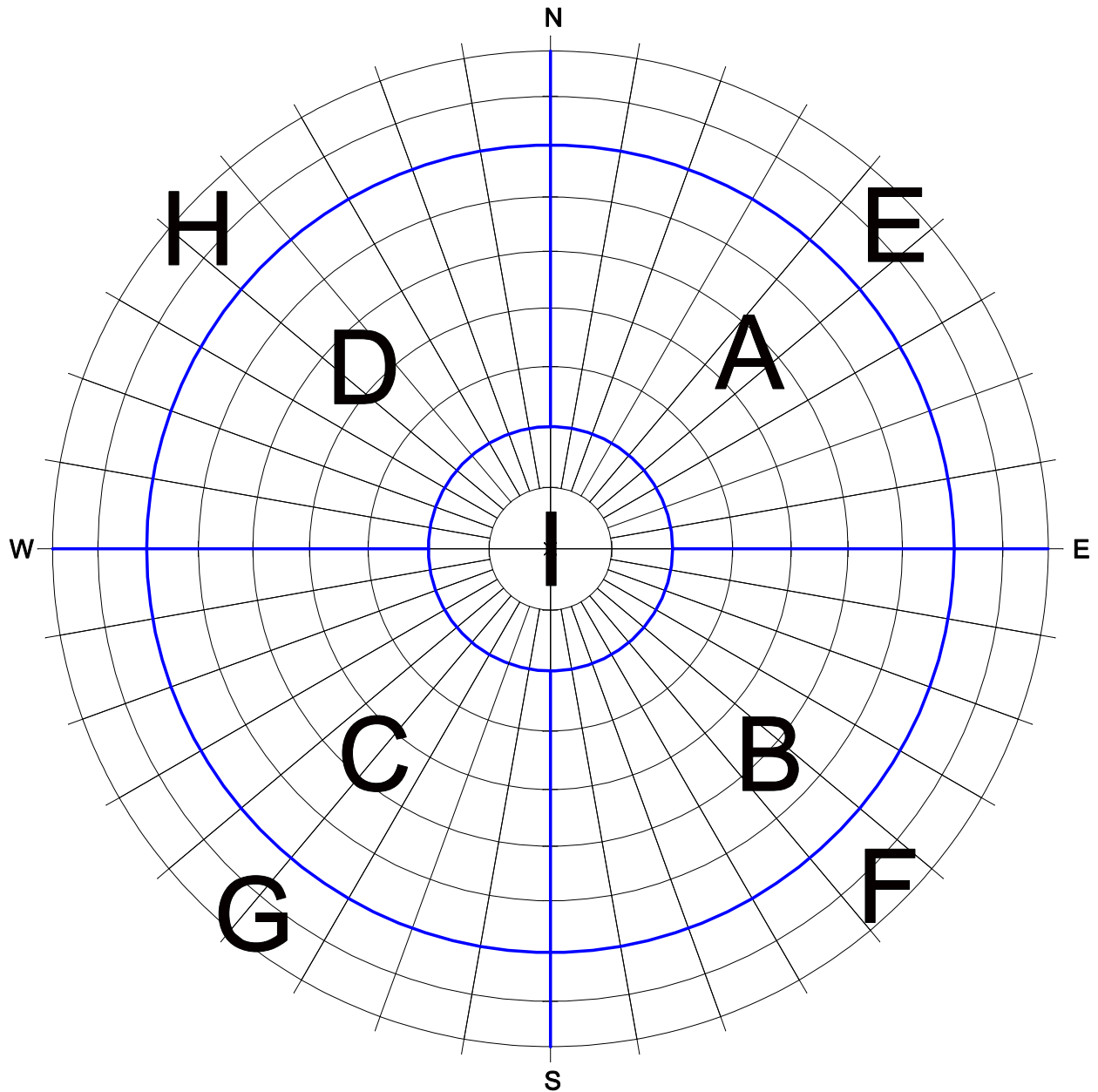

**NOTES:**

1. 1 - 2% CONTOUR INTERVAL USED AS CUT-OFF TO DEFINE SETS;



**BGC ENGINEERING INC.**  
AN APPLIED EARTH SCIENCES COMPANY

0638006 KSM Project PFSU OPD

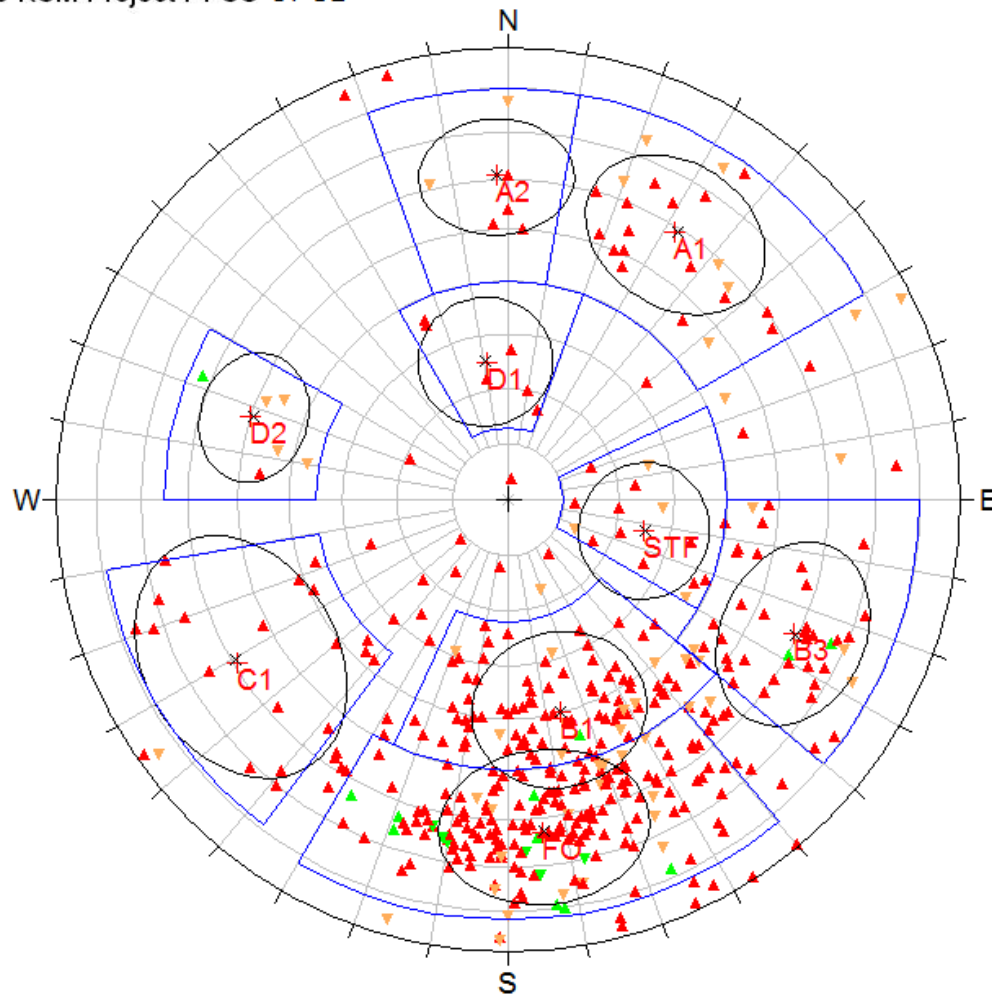

MASTER TYPE

- ▲ F [358]
- ▲ F-C [3]
- ▲ F-O [12]
- ▲ F-V [3]
- ▼ S [55]
- ▼ S-O [6]
- ▼ S-V [1]

---

Equal Area  
Lower Hemisphere  
438 Poles  
438 Entries

Mitchell - D1 Faults and Shears



0638006 KSM Project PFSU OPD

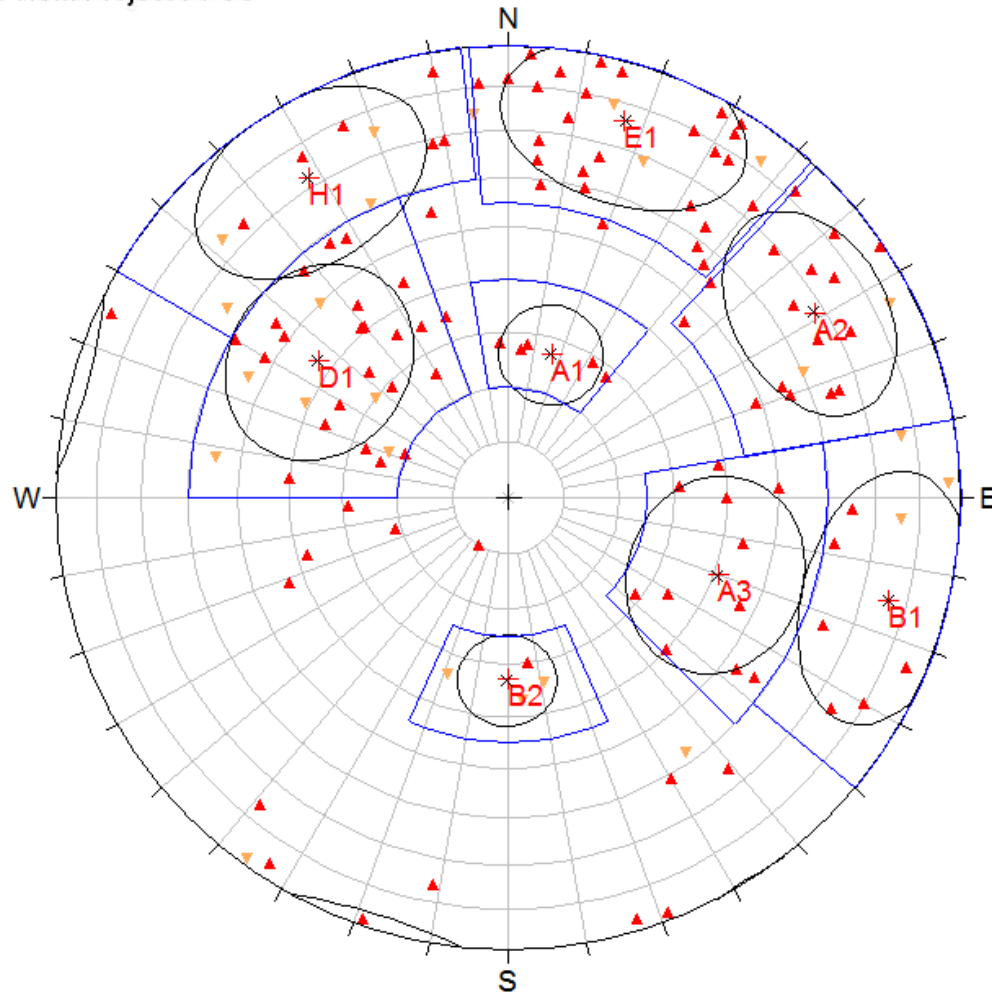

MASTER TYPE

- ▲ F [109]
- ▲ F-V [1]
- ▼ S [24]

---

Equal Area  
Lower Hemisphere  
134 Poles  
134 Entries

Mitchell - DII - Faults and Shears

0638006 KSM Project PFSU OPD

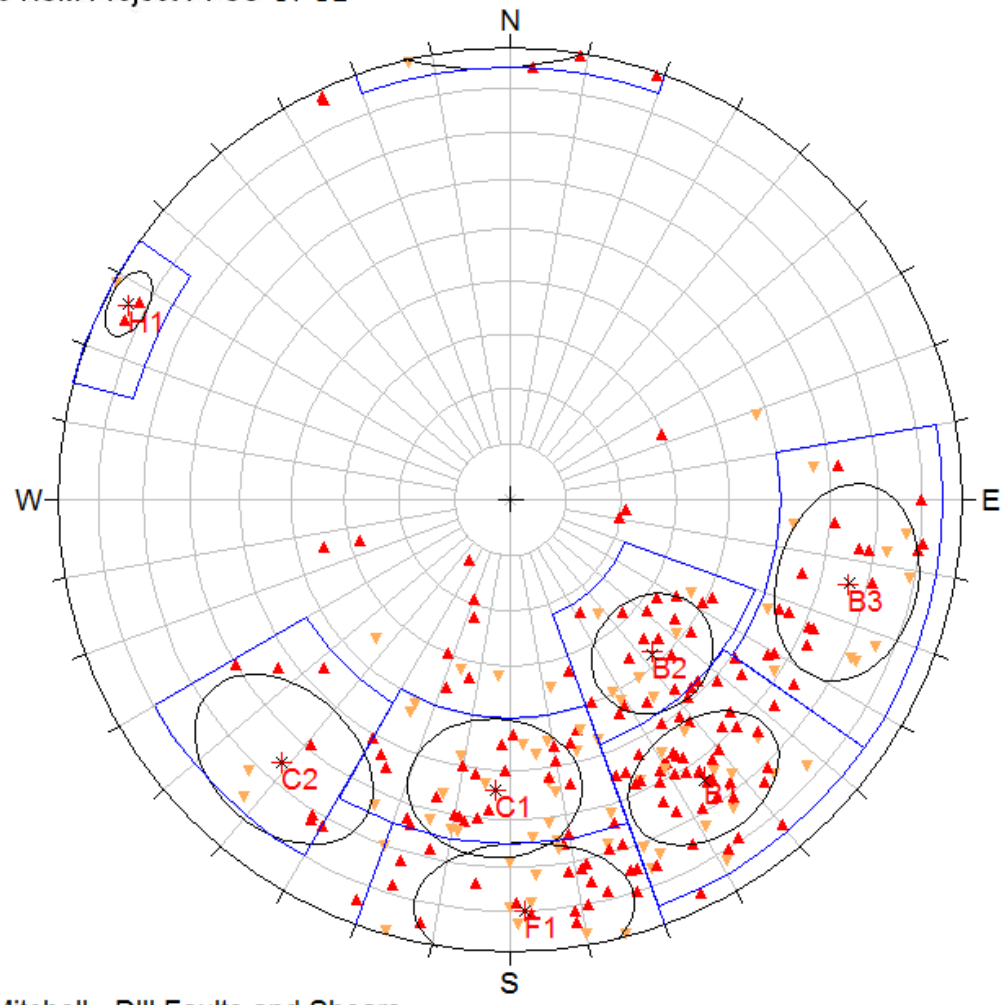

MASTER TYPE

- ▲ F [154]
- ▼ S [73]

---

Equal Area  
Lower Hemisphere  
227 Poles  
227 Entries

Mitchell - DIII Faults and Shears

0638006 KSM Project PFSU OPEN PIT SLOPE DESIGN

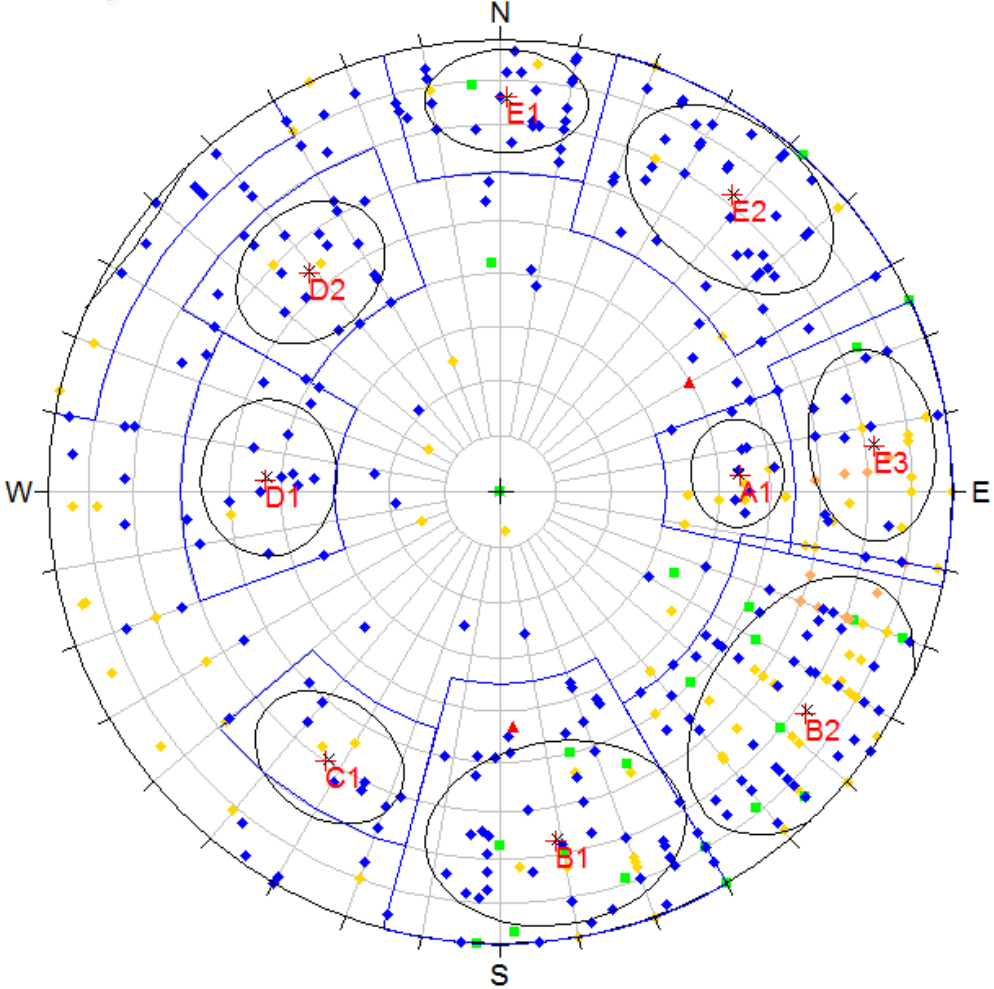

TYPE

- ◆ Bedding [93]
- Foliation [24]
- ◆ Inverted Bedding
- ◆ Joint [275]
- ▲ Normal Fault [2]

---

Equal Area  
Lower Hemisphere  
406 Poles  
406 Entries

IV - SEABRIDGE DATA

## **APPENDIX B STEREONETS BY GEOTECHNICAL DRILLHOLE**

## CORE HOLE AND PHOTOGRAMMETRY DISCONTINUITY DATA

Discontinuity data was collected for the PFS from both televiewer surveys of the core holes and photogrammetric mapping of the valley slopes. Additional data was available from Seabridge and MDRU geological mapping as well as BGC's 2008 PEA investigations.

The following stereonet present the discontinuity data collected in 2009 and reprocessed in 2011 for each drill hole. A blind zone has been shown on each stereonet to illustrate those orientations where structures would likely not be identified in the drill holes. The data has been symbolized by structure type, as identified by field staff using the following key (Table D-1).

**Table B-1: Discontinuity Codes**

CODE	Type	Description
B	Bedding	Layering due to depositional environment, if there is separation along it call: JT-BD or FT-BD.
C	Contact	Boundary between two different rock types.
X	Cleavage	Parallel, closely spaced planar surfaces independent of bedding produced by deformation
F	Fault	Displacement evident with infill (FG)
O	Foliation	Visible alignment of grains due to temperature and/or pressure
J	Joint	Little to no displacement
S	Shear	Polished or slickensided, no infill.
V	Vein	Geological discontinuity with mineral infilling

**Note:**

1. The above structure types may be hyphenated to describe compound structure types, such as a fault along bedding, F-B.

0638006 KSM Project PFSU OPSP

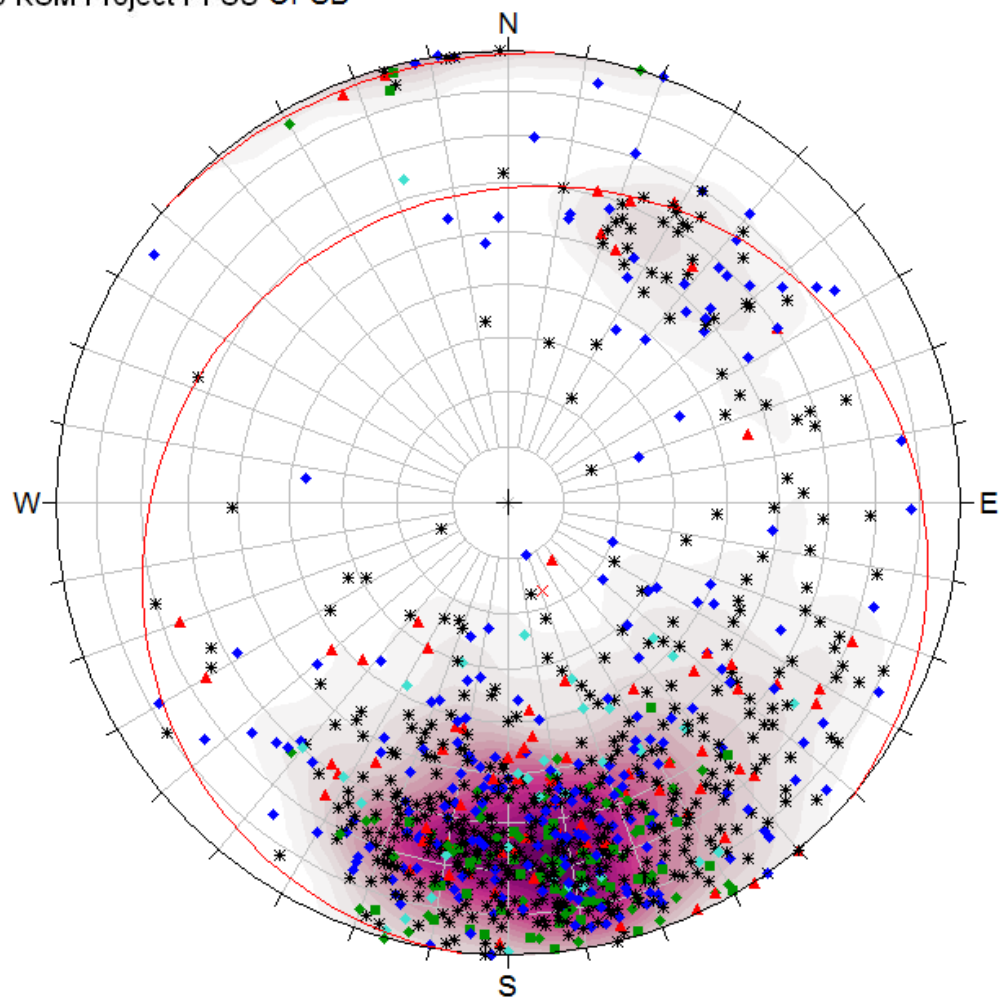

MASTER TYPE

- ▲ F [139]
- ▲ F-O [12]
- ◆ J [421]
- ◆ J-C [1]
- ◆ J-O [79]
- ◆ J-V [88]
- O [50]
- ▼ S [4]
- ▼ S-O [6]
- ▼ S-V [1]
- \* Others [127]

---

Equal Area  
Lower Hemisphere  
928 Poles  
928 Entries

M-09-095

0638006 KSM Project PFSU OPSD

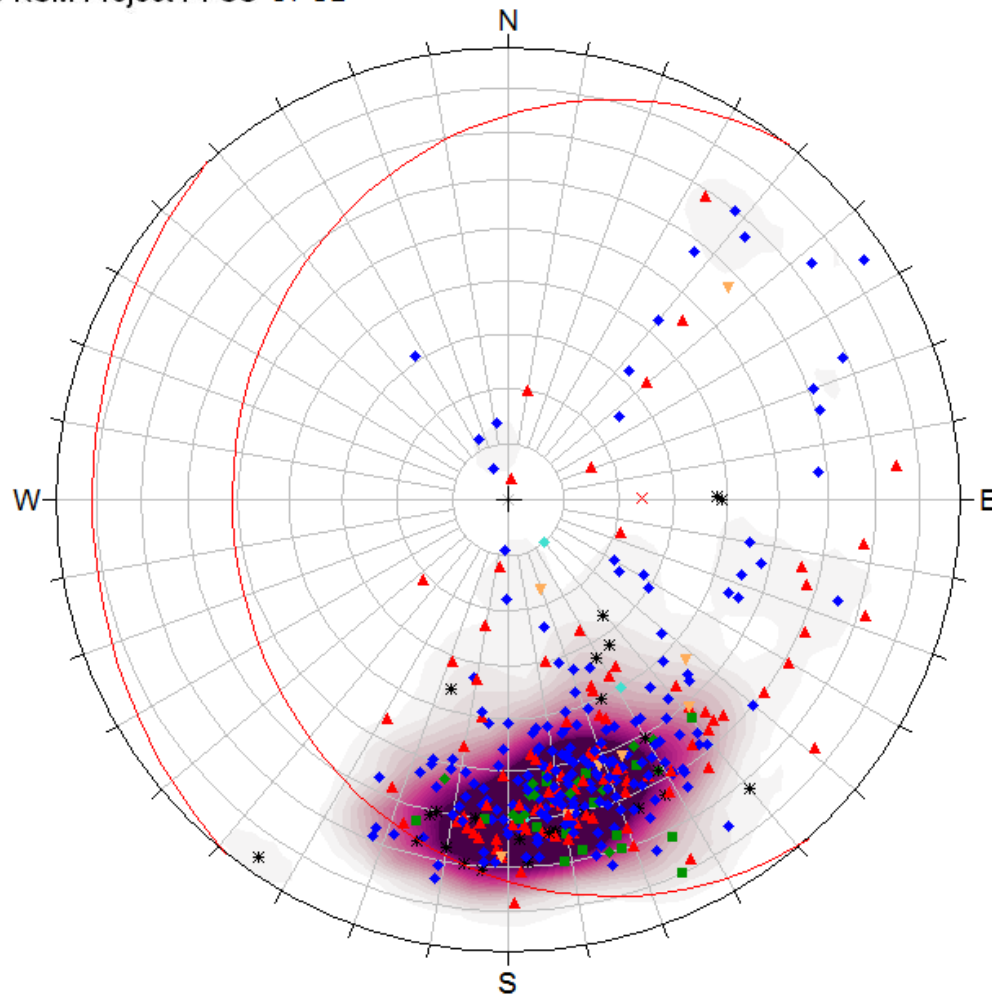

MASTER TYPE

- ▲ F [102]
- ◆ J [193]
- ◆ J-O [14]
- ◆ J-V [3]
- O [18]
- ▼ S [8]
- \* V [25]

---

Equal Area  
Lower Hemisphere  
363 Poles  
363 Entries

M-09-096

0638006 KSM Project PFSU OPSD

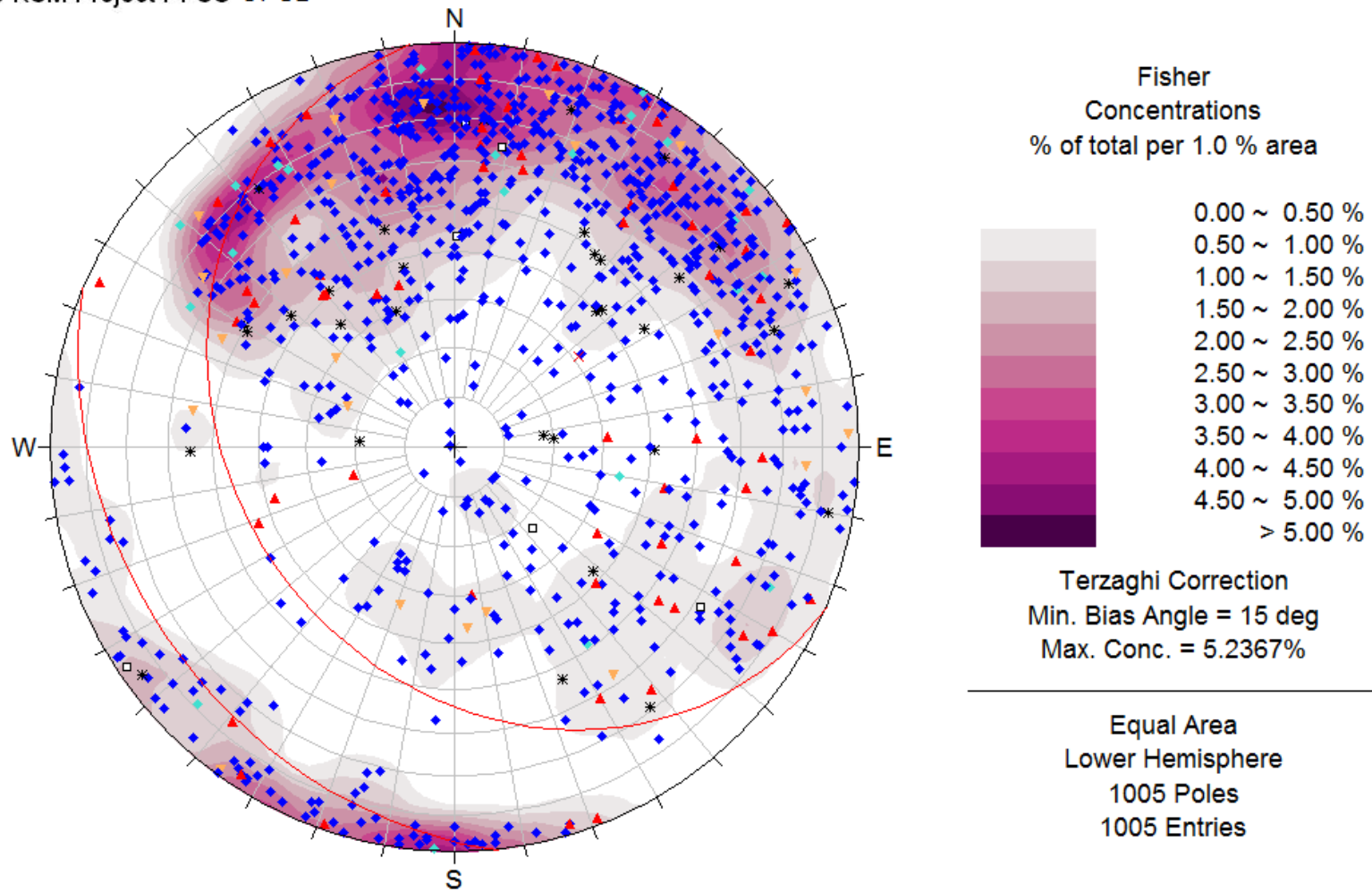

M-09-097



0638006 KSM Project PFSU OPD

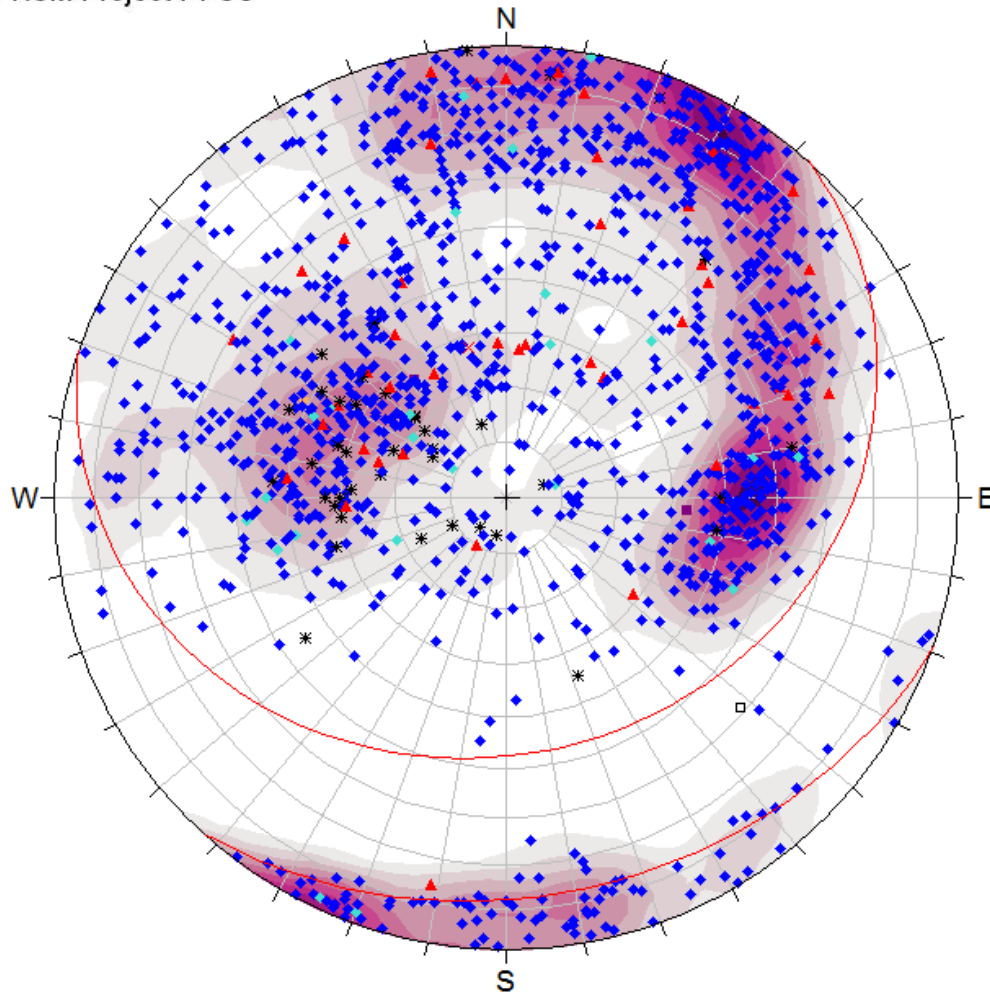

MASTER TYPE

- C [2]
- ▲ F [46]
- ◆ J [1212]
- ◆ J-B [1]
- ◆ J-V [25]
- ▼ S [1]
- \* V [41]
- ◆ j [1]
- n/a [1]

---

Equal Area  
Lower Hemisphere  
1330 Poles  
1330 Entries

M-09-098

0638006 KSM Project PFSU OPSP

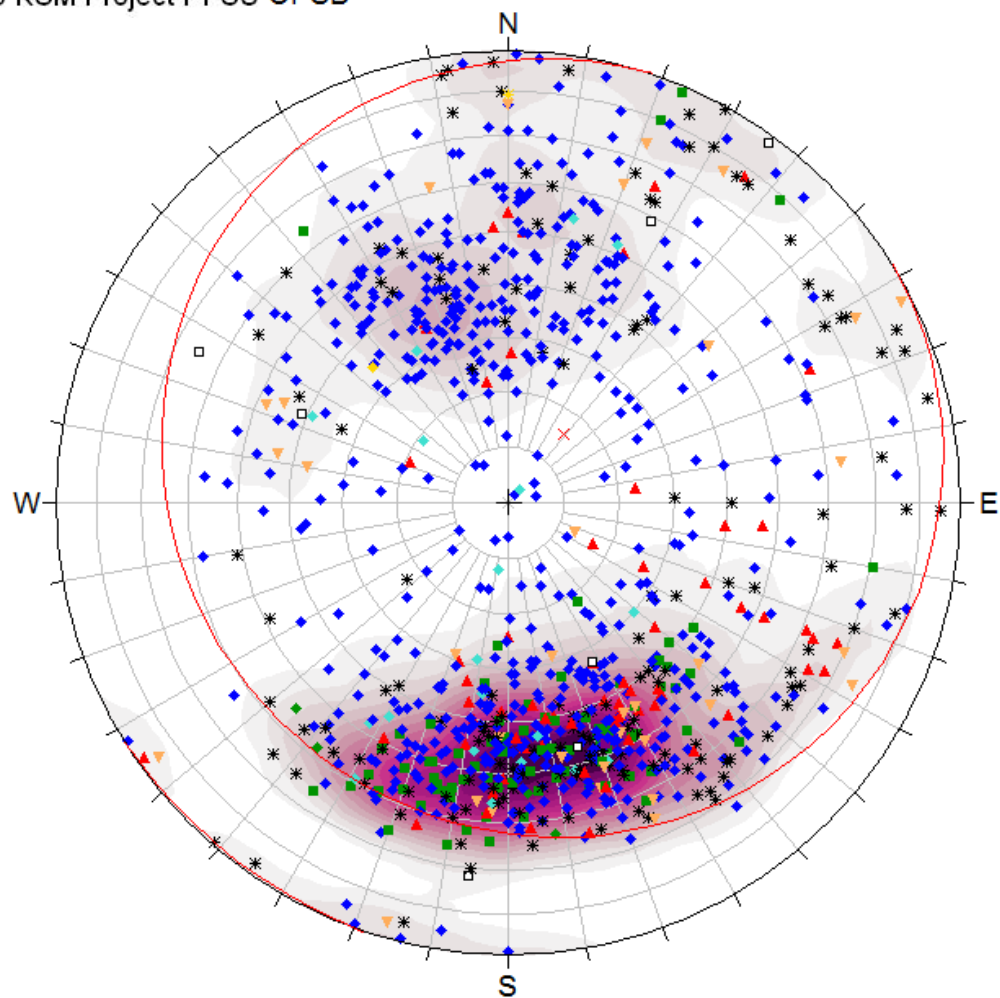

MASTER TYPE

- ◆ AN-J [1]
- \* AN-V [1]
- C [1]
- ▲ F [65]
- ◆ J [579]
- ◆ J-O [6]
- ◆ J-V [20]
- O [82]
- ▼ S [34]
- \* V [162]
- Others [7]

---

Equal Area  
Lower Hemisphere  
958 Poles  
958 Entries

M-09-099

0638006 KSM Project PFSU OPSD

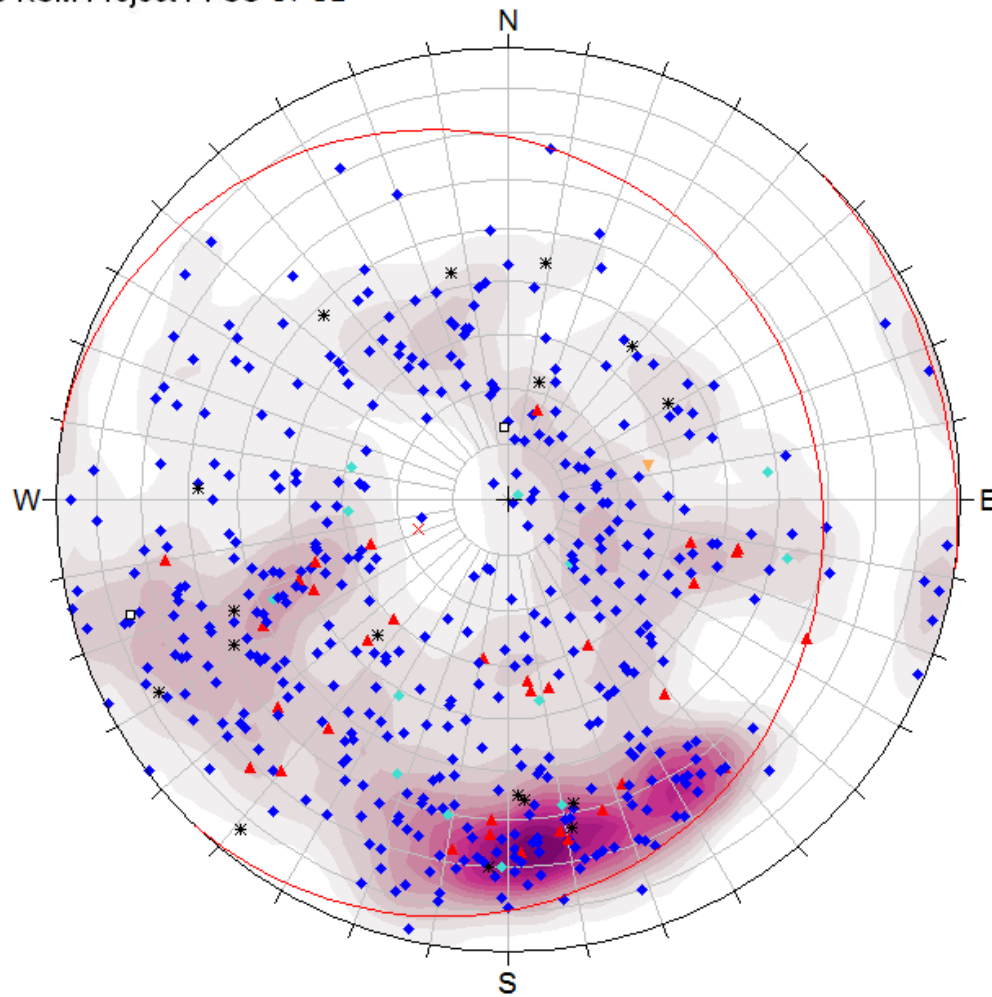

MASTER TYPE

- ▲ F [33]
- ◆ J [424]
- ◆ J-V [13]
- ▼ S [1]
- \* V [17]
- n/a [2]

---

Equal Area  
Lower Hemisphere  
490 Poles  
490 Entries

M-09-100

0638006 KSM Project PFSU OPSD

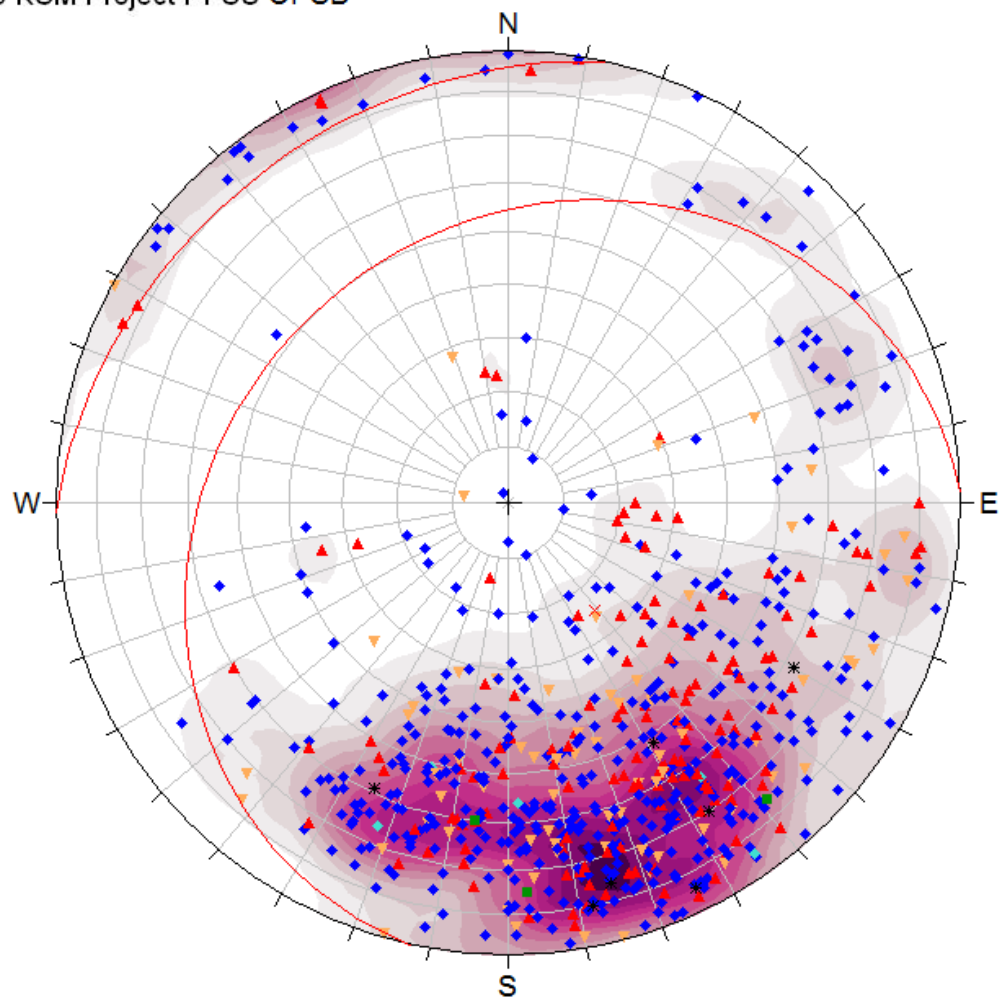

MASTER TYPE

- ▲ F [143]
- ◆ J [416]
- ◆ J-V [5]
- O [3]
- ▼ S [69]
- ▼ S-V [2]
- \* V [7]

---

Equal Area  
Lower Hemisphere  
645 Poles  
645 Entries

M-09-101

0638006 KSM Project PFSU OPSP

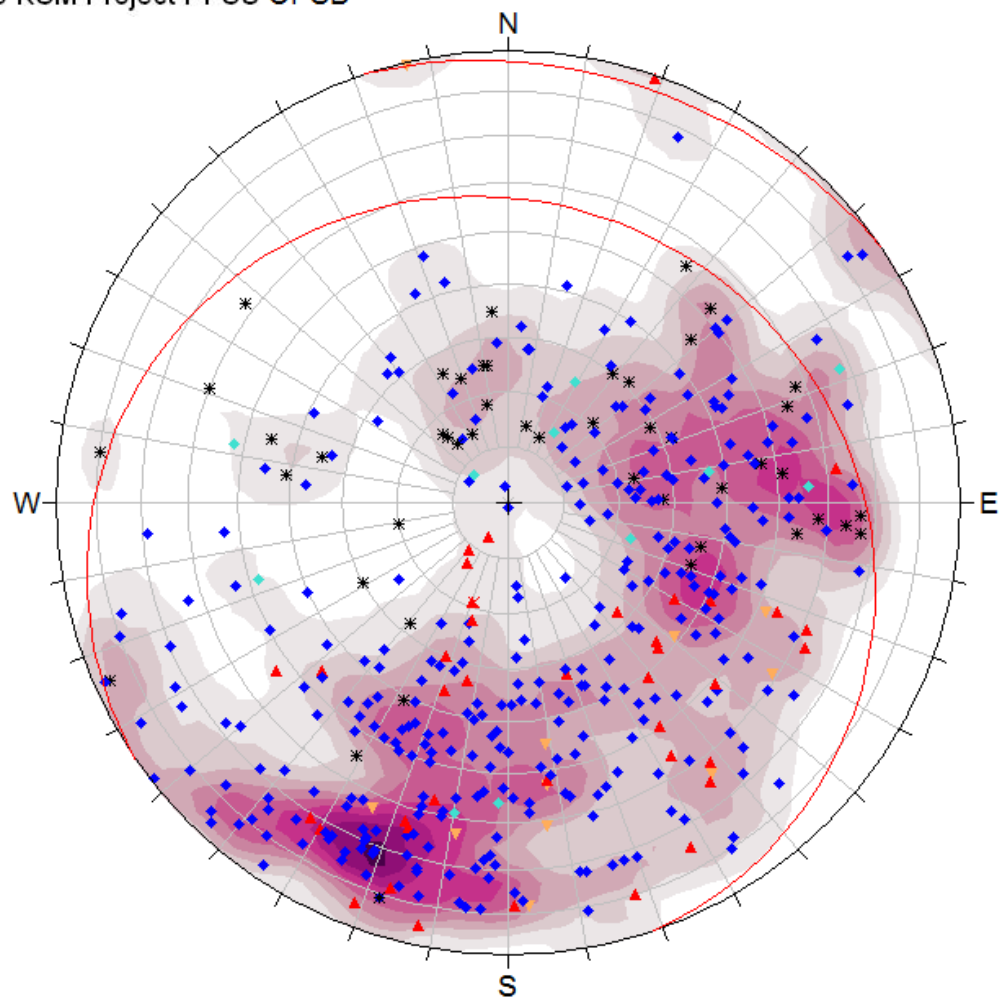

MASTER TYPE

- ▲ F [39]
- ◆ J [311]
- ◆ J-V [11]
- ▼ S [11]
- \* V [47]

---

Equal Area  
Lower Hemisphere  
419 Poles  
419 Entries

M-09-102

0638006 KSM Project PFSU OPSD

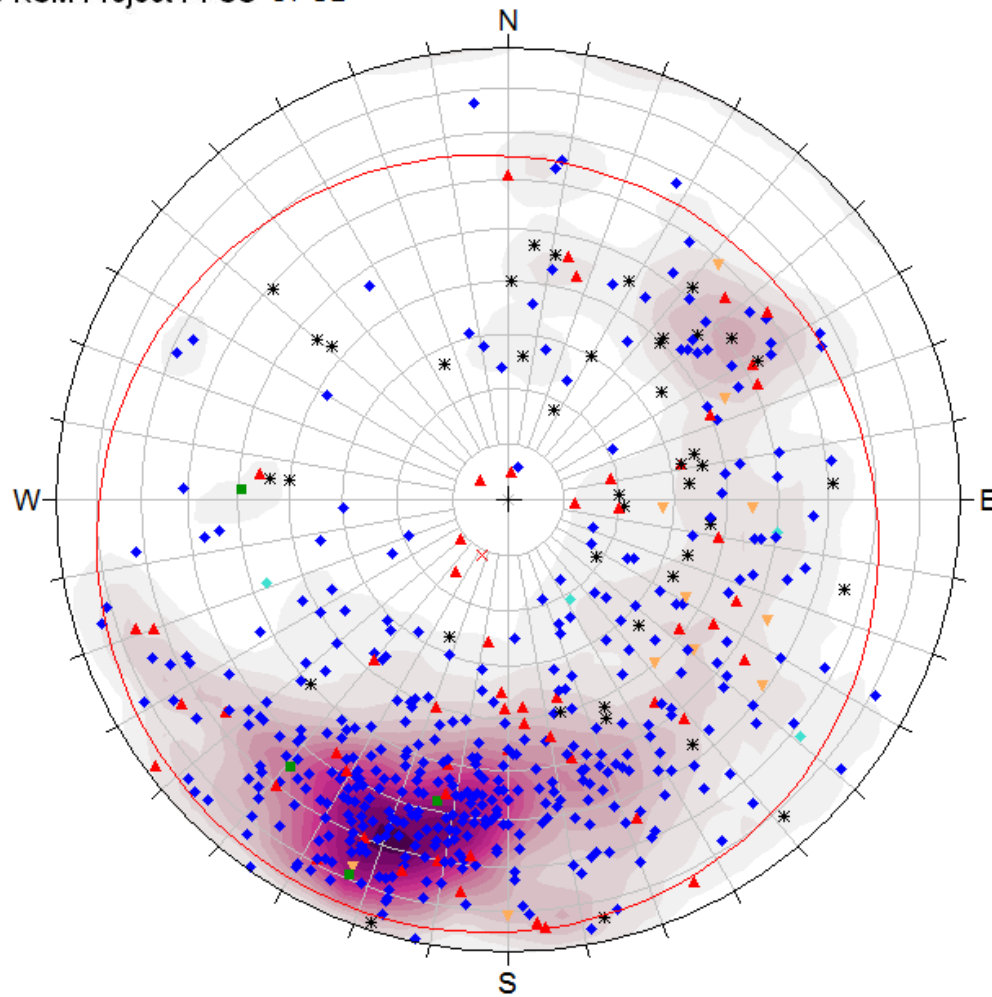

MASTER TYPE

- ▲ F [55]
- ◆ J [400]
- ◆ J-V [4]
- O [4]
- ▼ S [11]
- \* V [42]

---

Equal Area  
Lower Hemisphere  
516 Poles  
516 Entries

M-09-102a

## **APPENDIX C PIT DESIGN CONFIRMATION SECTIONS**

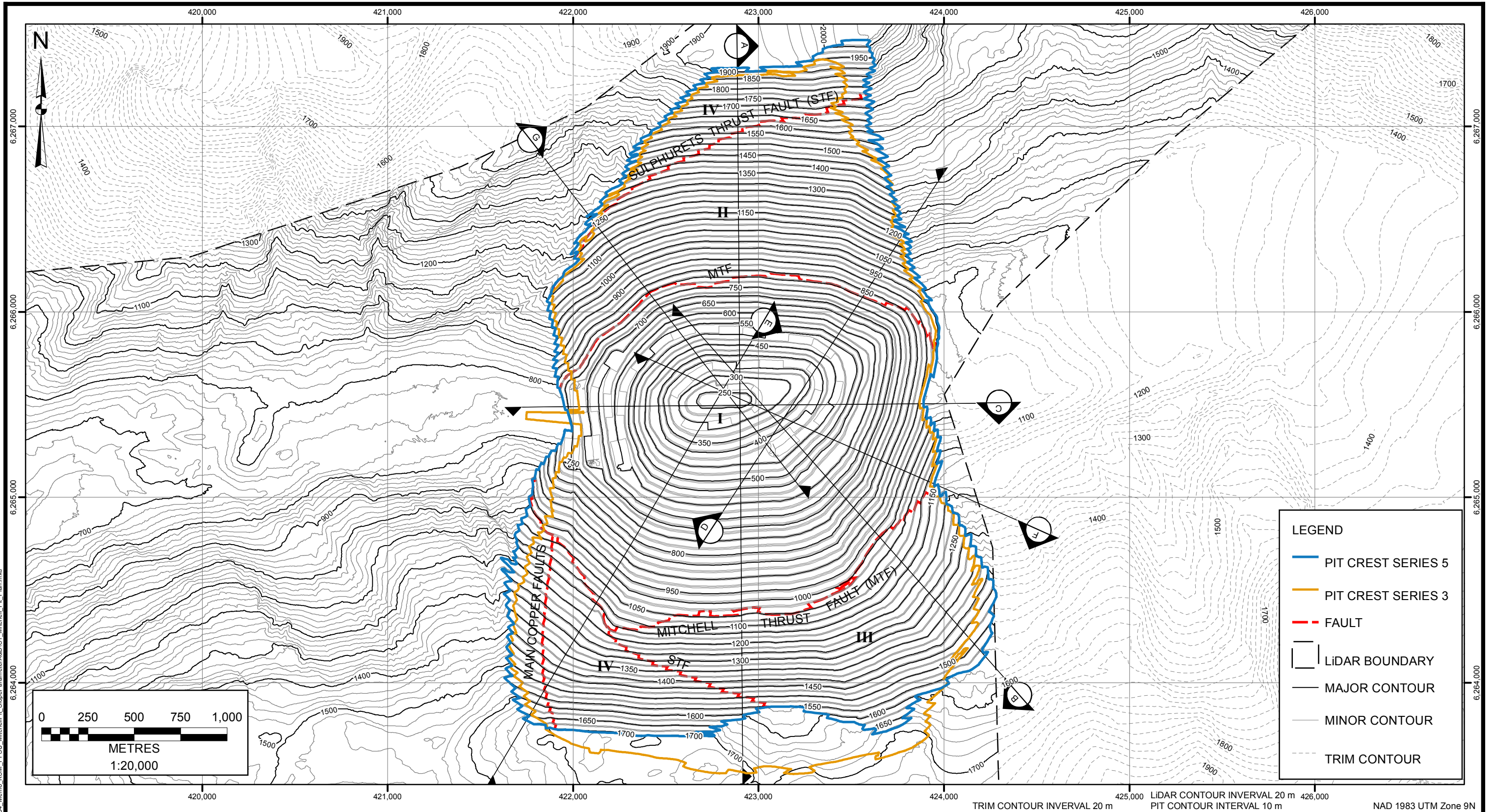

<small>AS A MUTUAL PROTECTION TO OUR CLIENT, THE PUBLIC, AND OURSELVES, ALL REPORTS AND DRAWINGS ARE SUBMITTED FOR THE CONFIDENTIAL INFORMATION OF OUR CLIENT FOR A SPECIFIC PROJECT. AUTHORIZATION FOR ANY USE AND/OR PUBLICATION OF THIS REPORT OR ANY DATA, STATEMENTS, CONCLUSIONS OR ABSTRACTS FROM OR REGARDING OUR REPORTS AND DRAWINGS, THROUGH ANY FORM OF PRINT OR ELECTRONIC MEDIA, INCLUDING WITHOUT LIMITATION, POSTING OR REPRODUCTION OF SAME ON ANY WEBSITE, IS RESERVED PENDING BGC'S WRITTEN APPROVAL. IF THIS REPORT IS ISSUED IN AN ELECTRONIC FORMAT, AN ORIGINAL PAPER COPY IS ON FILE AT BGC ENGINEERING INC. AND THAT COPY IS THE PRIMARY REFERENCE WITH PRECEDENCE OVER ANY ELECTRONIC COPY OF THE DOCUMENT, OR ANY EXTRACTS FROM OUR DOCUMENTS PUBLISHED BY OTHERS.</small>					SCALE:	1:20,000	PROFESSIONAL SEAL:   <b>BGC ENGINEERING INC.</b> AN APPLIED EARTH SCIENCES COMPANY	PROJECT:																															
					DATE:	JUN 2011		KSM PROJECT PRE-FEASIBILITY STUDY UPDATE - MITCHELL PIT SLOPE PARAMETER ADDENDUM AND CONFIRMATION																															
<table border="1"> <thead> <tr> <th>REV.</th> <th>DATE</th> <th>REVISION NOTES</th> <th>DRAWN</th> <th>CHECK</th> <th>APPR.</th> </tr> </thead> <tbody> <tr> <td> </td> <td> </td> <td> </td> <td> </td> <td> </td> <td> </td> </tr> <tr> <td> </td> <td> </td> <td> </td> <td> </td> <td> </td> <td> </td> </tr> <tr> <td> </td> <td> </td> <td> </td> <td> </td> <td> </td> <td> </td> </tr> <tr> <td> </td> <td> </td> <td> </td> <td> </td> <td> </td> <td> </td> </tr> </tbody> </table>					REV.	DATE	REVISION NOTES	DRAWN	CHECK	APPR.																									DRAWN:	MIB	TITLE:		
					REV.	DATE	REVISION NOTES	DRAWN	CHECK	APPR.																													
<table border="1"> <tr> <td>CLIENT:</td> <td colspan="3">SEABRIDGE GOLD INC.</td> </tr> <tr> <td>PROJECT No.:</td> <td>0638-006-05</td> <td>DWG No.:</td> <td>C1</td> <td>REV.:</td> <td> </td> </tr> </table>					CLIENT:	SEABRIDGE GOLD INC.			PROJECT No.:	0638-006-05	DWG No.:	C1	REV.:		DESIGNED:	MAB	MITCHELL PIT CHECKING PLAN MAP																						
					CLIENT:	SEABRIDGE GOLD INC.																																	
PROJECT No.:	0638-006-05	DWG No.:	C1	REV.:																																			
<table border="1"> <tr> <td>APPROVED:</td> <td>HWN</td> <td colspan="4"> </td> </tr> </table>					APPROVED:	HWN					CHECKED:	DK																											
					APPROVED:	HWN																																	

DWG TO BE READ WITH BGC MEMO TITLED "KSM PROJECT PRE-FEASIBILITY STUDY UPDATE - MITCHELL PIT SLOPE PARAMETER ADDENDUM AND CONFIRMATION" DATED JUNE 15, 2011



A

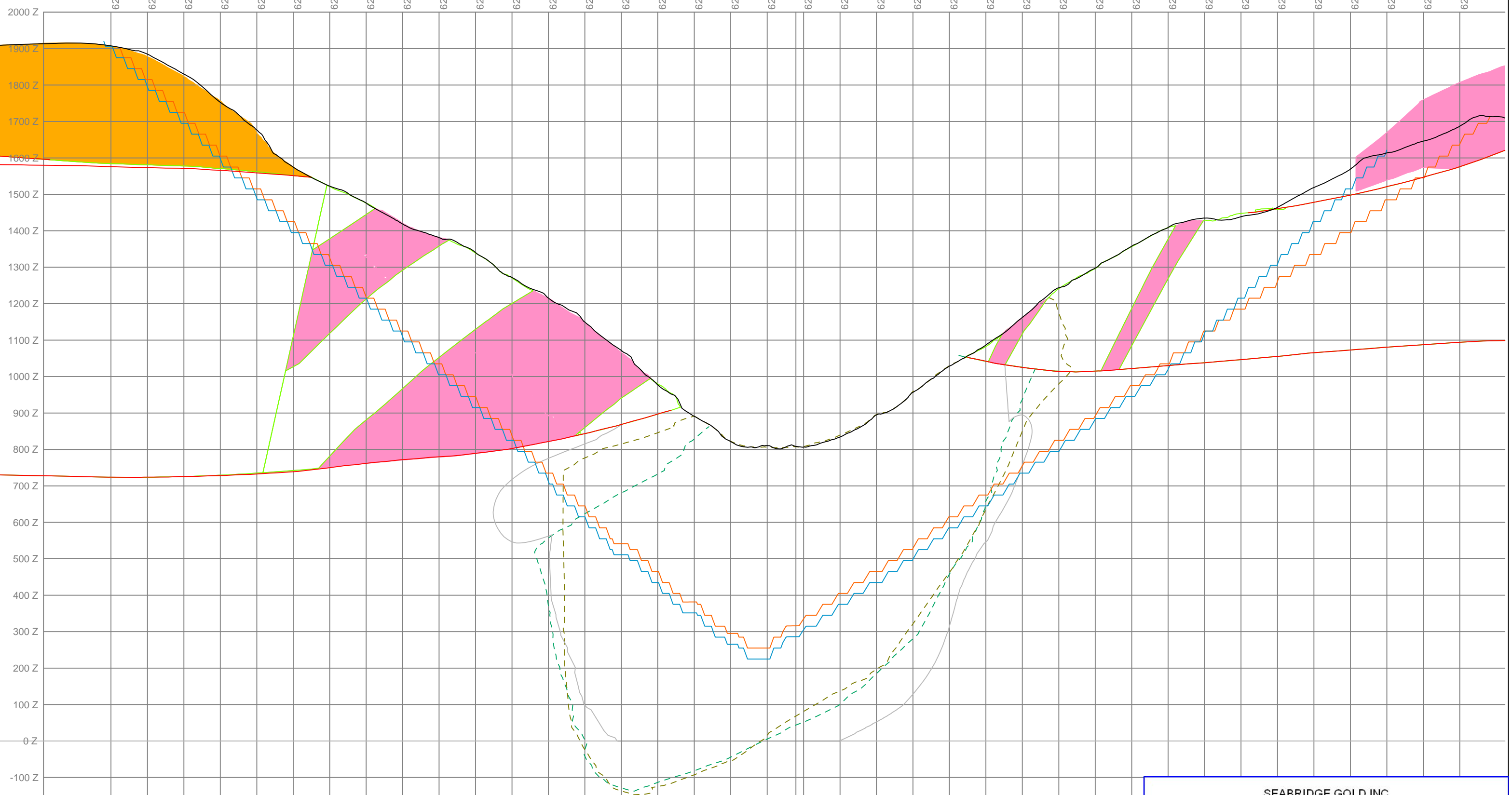

object sections

TOPOGRAPHY	20110318 SERIES 5 PIT	MC HAZL VOLC	STUHINI GROUP	0.25g Au
FAULTS	20110309 SERIES 3 PIT	MC MONZ	UNCATEGORIZED	0.1% Cu

**SEABRIDGE GOLD INC**

**KSM PROJECT PRE-FEASIBILITY STUDY UPDATE  
- MITCHELL OPEN PIT SLOPE DESIGNS  
SECTION A 20110421 - WKL**

Scale: 1:	10000	Plan No.	Date: 15-Jun-11
-----------	-------	----------	-----------------

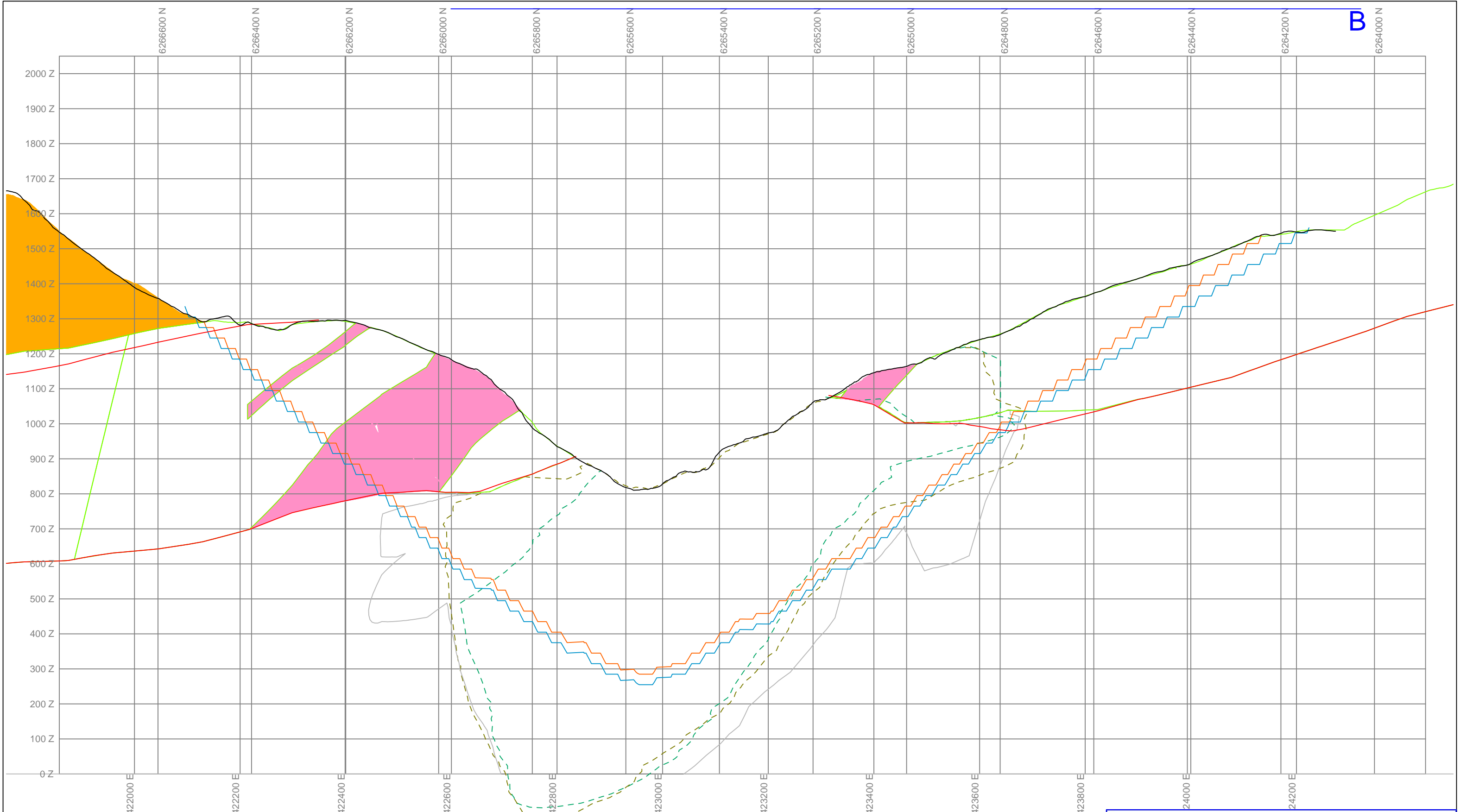

**B**

object sections

TOPOGRAPHY	20110318 SERIES 5 PIT	MC HAZL VOLC	STUHINI GROUP	0.25g Au
FAULTS	20110309 SERIES 3 PIT	MC MONZ	UNCATEGORIZED	0.1% Cu

<b>SEABRIDGE GOLD INC</b>			
KSM PROJECT PRE-FEASIBILITY STUDY UPDATE - MITCHELL OPEN PIT SLOPE DESIGNS SECTION B 20110421 - WKL			
Scale: 1:	10000	Plan No.	Date: 15-Jun-11

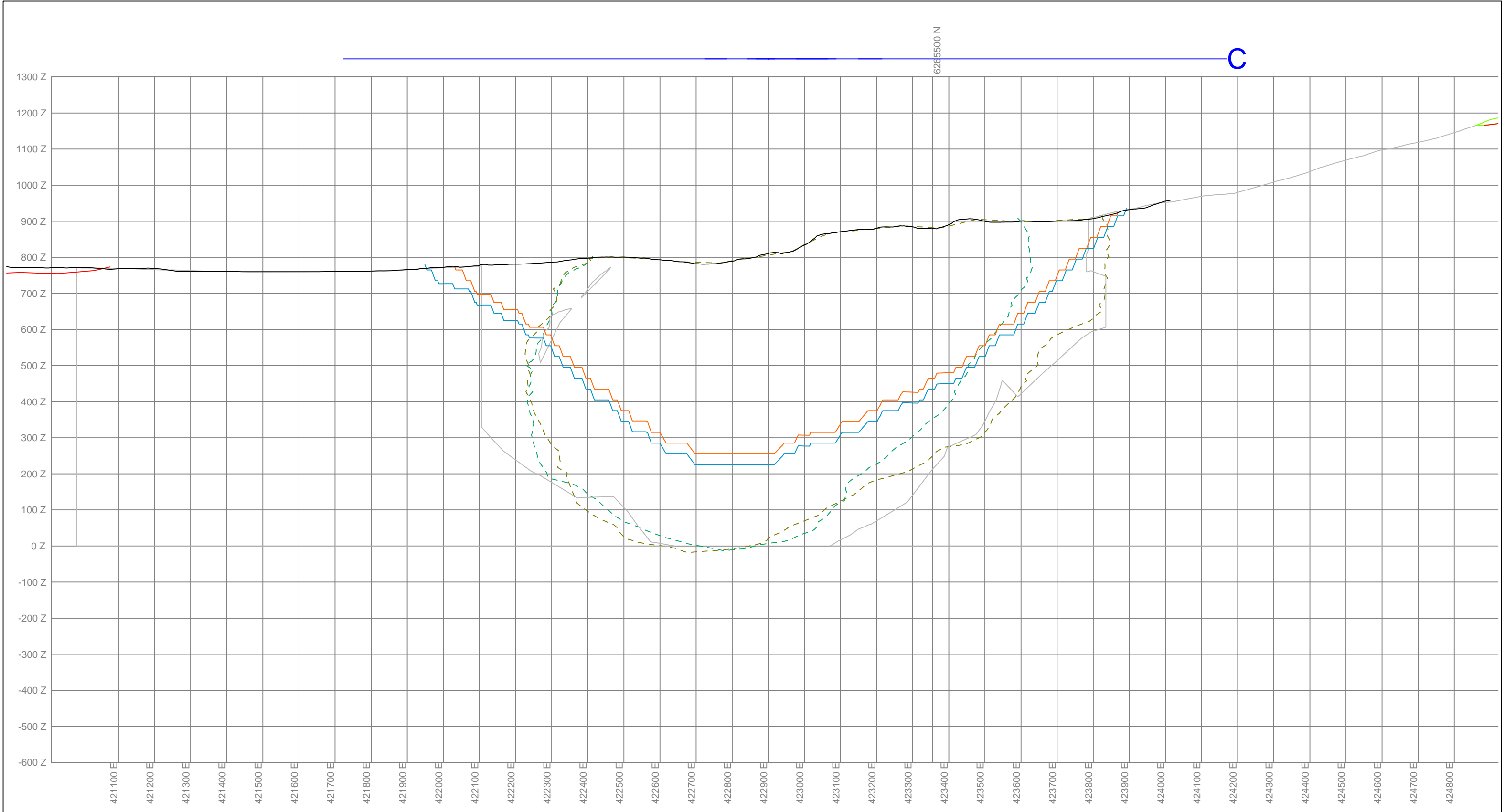

object sections

TOPOGRAPHY	20110318 SERIES 5 PIT	MC HAZL VOLC	0.25g Au
FAULTS	20110309 SERIES 3 PIT	UNCATEGORIZED	0.1% Cu

**SEABRIDGE GOLD INC**

**KSM PROJECT PRE-FEASIBILITY STUDY UPDATE  
- MITCHELL OPEN PIT SLOPE DESIGNS  
SECTION C 20110421 - WKL**

Scale: 1:	10000	Plan No.	Date:	15-Jun-11
-----------	-------	----------	-------	-----------

section\_m\_d\_02

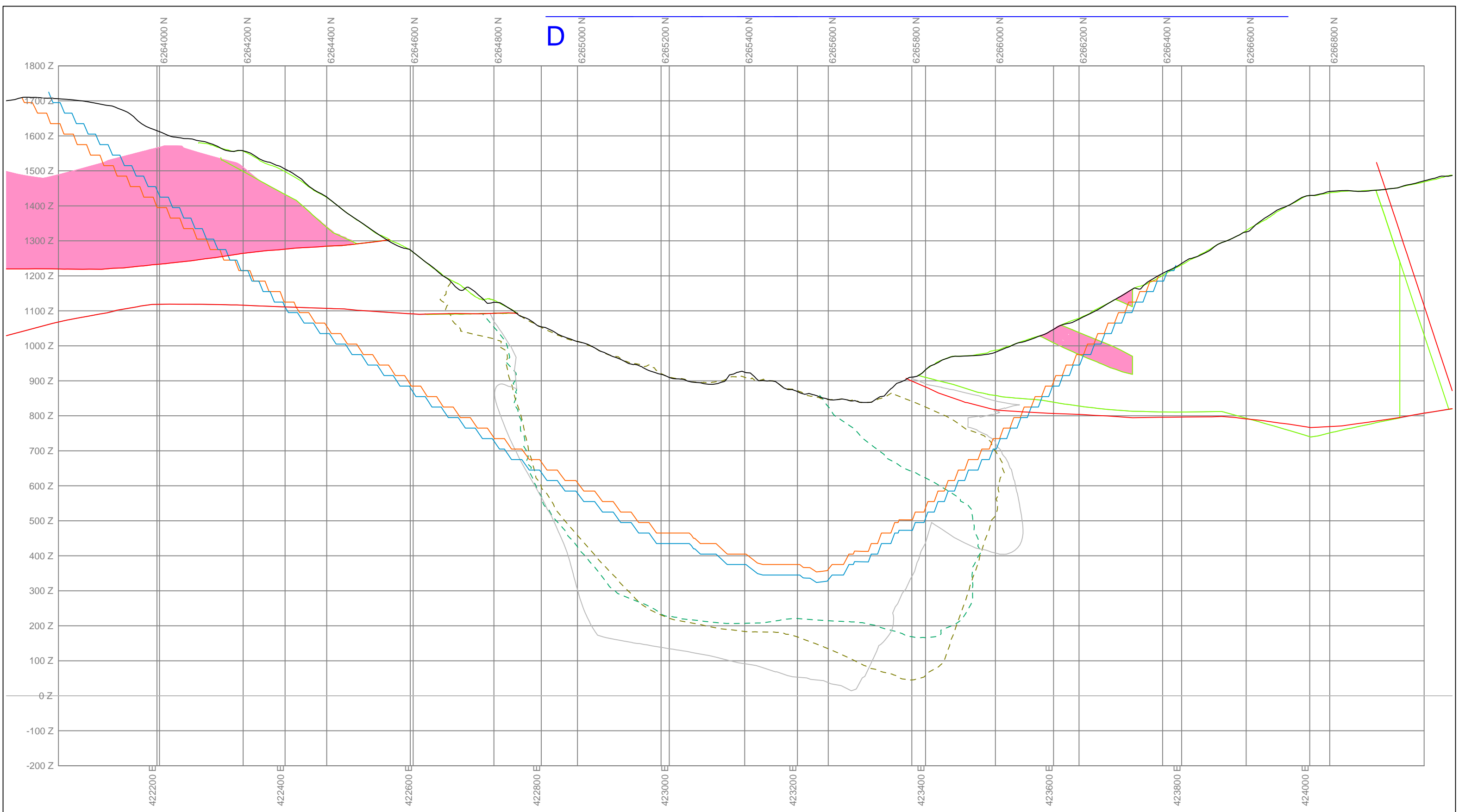

D

object sections				
TOPOGRAPHY	20110318 SERIES 5 PIT	MC HAZL VOLC	UNCATEGORIZED	0.1% Cu
FAULTS	20110309 SERIES 3 PIT	MC MONZ	0.25g Au	

<b>SEABRIDGE GOLD INC</b>			
<b>KSM PROJECT PRE-FEASIBILITY STUDY UPDATE - MITCHELL OPEN PIT SLOPE DESIGNS SECTION D 20110421 - WKL</b>			
Scale: 1:	10000	Plan No.	Date: 15-Jun-11

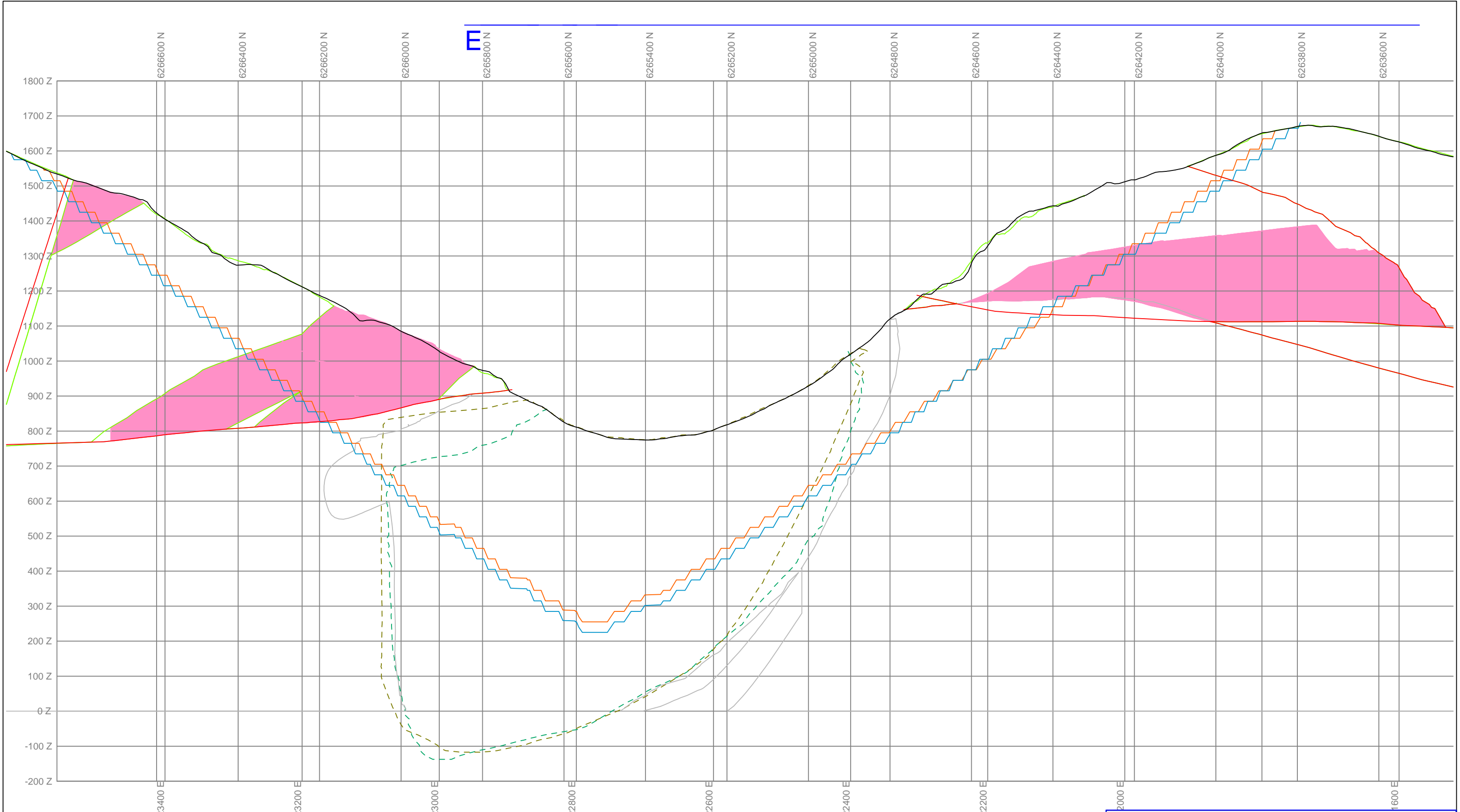

object sections

TOPOGRAPHY	20110318 SERIES 5 PIT	MC HAZL VOLC	STUHINI GROUP	0.25g Au	0.1% Cu
FAULTS	20110309 SERIES 3 PIT	MC MONZ	UNCATEGORIZED	UP AU CU	

**SEABRIDGE GOLD INC**

**KSM PROJECT PRE-FEASIBILITY STUDY UPDATE  
- MITCHELL OPEN PIT SLOPE DESIGNS  
SECTION E 20110421 - WKL**

Scale: 1:	10000	Plan No.	Date:	15-Jun-11
-----------	-------	----------	-------	-----------

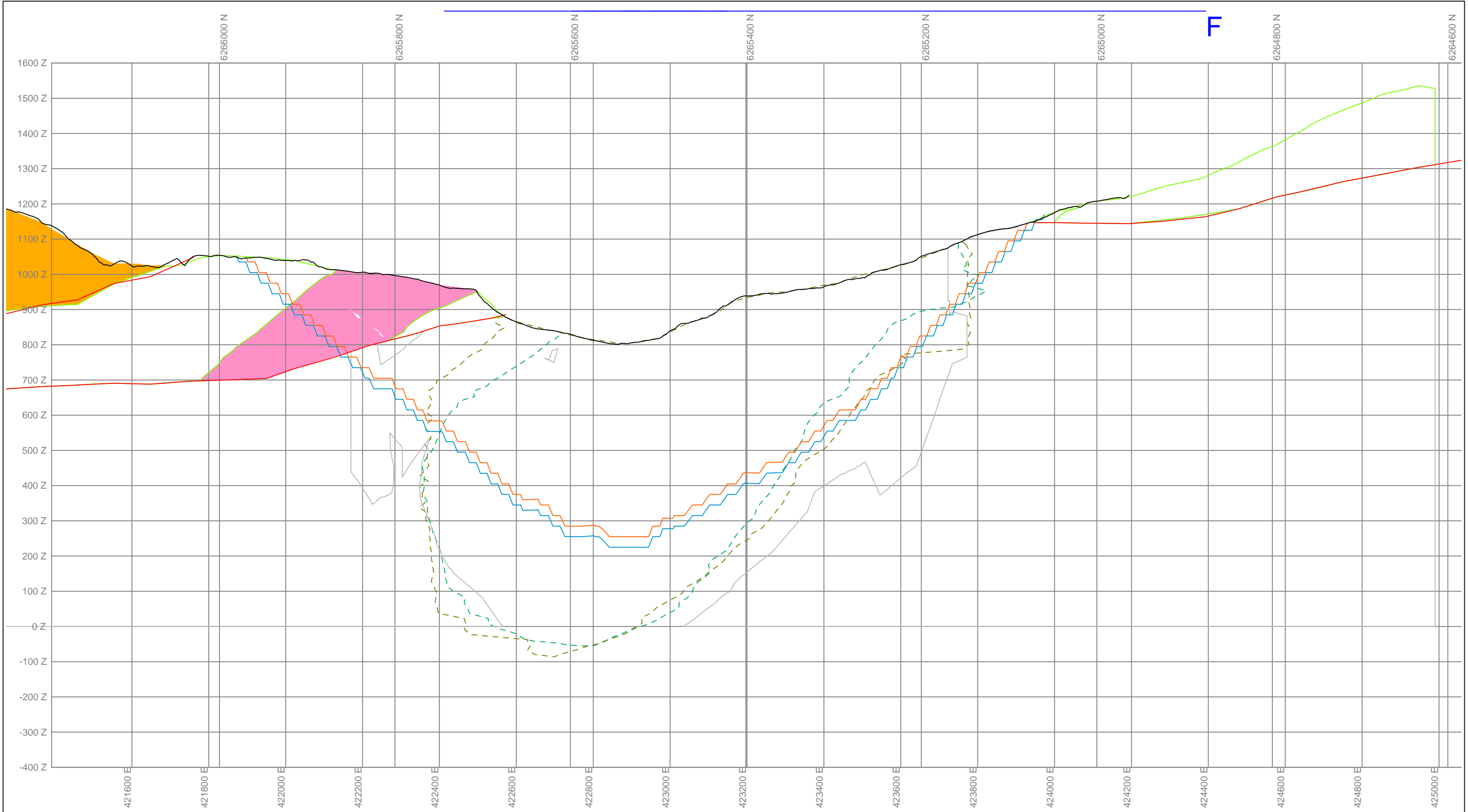

object sections				
TOPOGRAPHY	20110318 SERIES 5 PIT	MC HAZL VOLC	STUHINI GROUP	0.25g Au
FAULTS	20110309 SERIES 3 PIT	MC MONZ	UNCATEGORIZED	0.1% Cu

<b>SEABRIDGE GOLD INC</b>			
KSM PROJECT PRE-FEASIBILITY STUDY UPDATE - MITCHELL OPEN PIT SLOPE DESIGNS SECTION F 20110421 - WKL			
Scale: 1:	10000	Plan No.	Date: 15-Jun-11

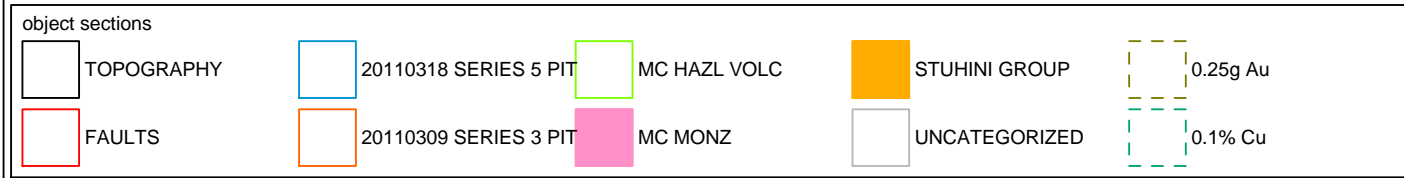
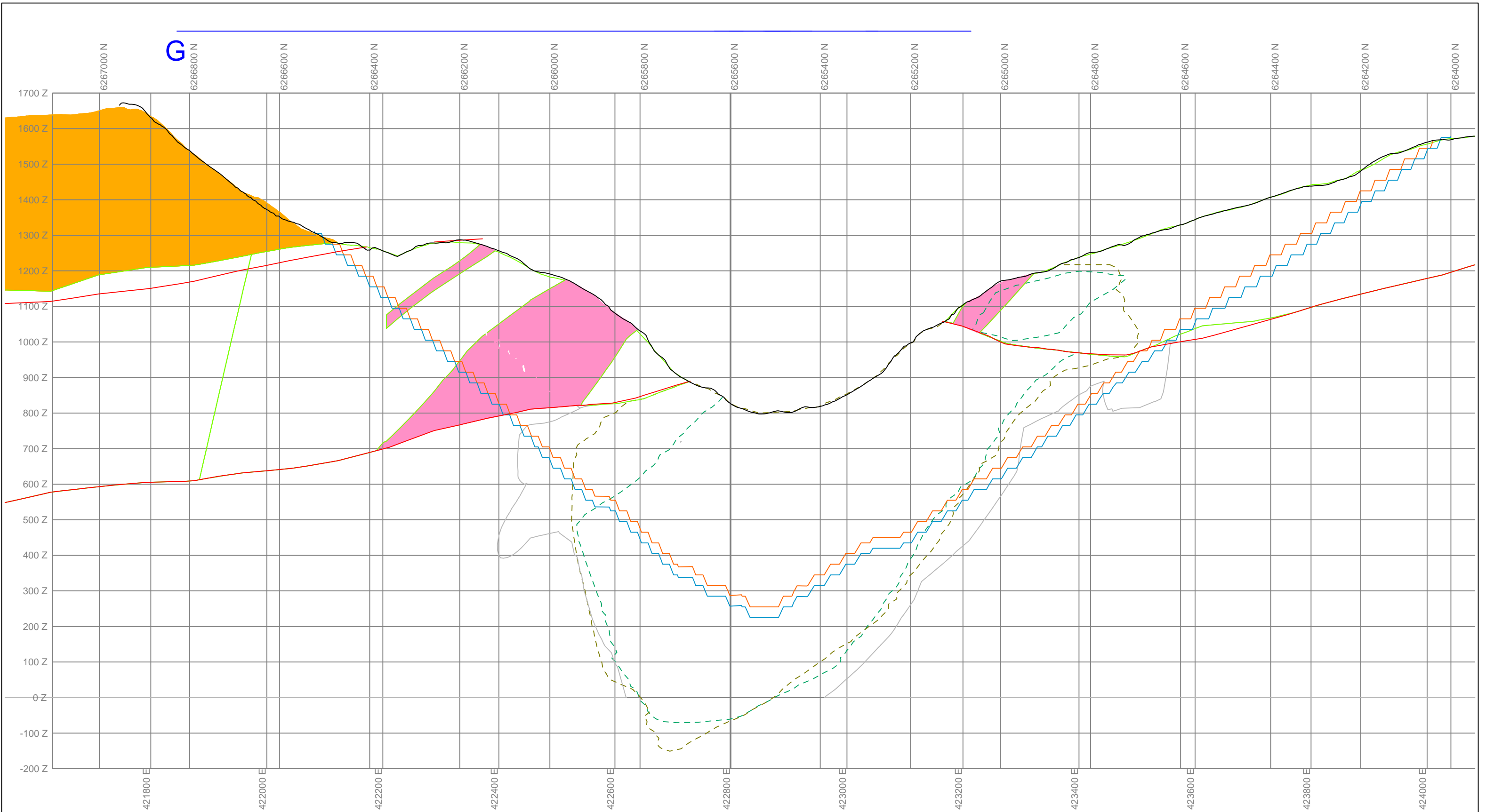

<b>SEABRIDGE GOLD INC</b>			
<b>KSM PROJECT PRE-FEASIBILITY STUDY UPDATE - MITCHELL OPEN PIT SLOPE DESIGNS SECTION G 20110421 - WKL</b>			
Scale: 1:	10000	Plan No.	Date: 15-Jun-11

## **APPENDIX D OVERALL SLOPE ANALYSES**







Table D1: Summary of Mitchell Pit Stability Analyses

<b>Analysis Name</b>	<b>Slope</b>	<b>Case</b>	<b>Overall Factor of Safety<sup>1</sup></b>	<b>Design Angle Control<sup>2</sup></b>
A1	North	Design Base Case	1.30	Overall Stability
A2	South	Design Base Case	1.42	Interberm Structural Failure
B1	Southeast	Design Base Case	1.44	Interberm Structural Failure
B2	Southeast	Anisotropic DIII	1.40	Interberm Structural Failure
C1	West	Design Base Case	2.25	Interberm Structural Failure
C2	East	Design Base Case	2.20	Interberm Structural Failure

Notes:

- Analyses for A1 and A2 were completed using watertable surfaces from BGC's 3d groundwater model with an assumed zone of influence from proposed horizontal drain lengths. The other sections have been analyzed with an assumed watertable based on pre-mining conditions and an assumed zone of influence from proposed horizontal drains. (BGC, 2011)
- Refer to Table 1 for specific structural sets defining interberm design angle control.

Material Name	Color	Unit Weight (kN/m3)	Strength Type	UCS (kN/m2)	m	s	a
SIL-MTH		27	Generalised Hoek-Brown	92000	1.331	0.0024	0.5
QSP Iso		28	Generalised Hoek-Brown	61000	2.54	0.0207	0.5
INT		26	Generalised Hoek-Brown	113000	1.492	0.0023	0.5
KP		26	Generalised Hoek-Brown	90000	1.134	0.0011	0.5
Stuhini		27	Generalised Hoek-Brown	66000	1.286	0.0004	0.5

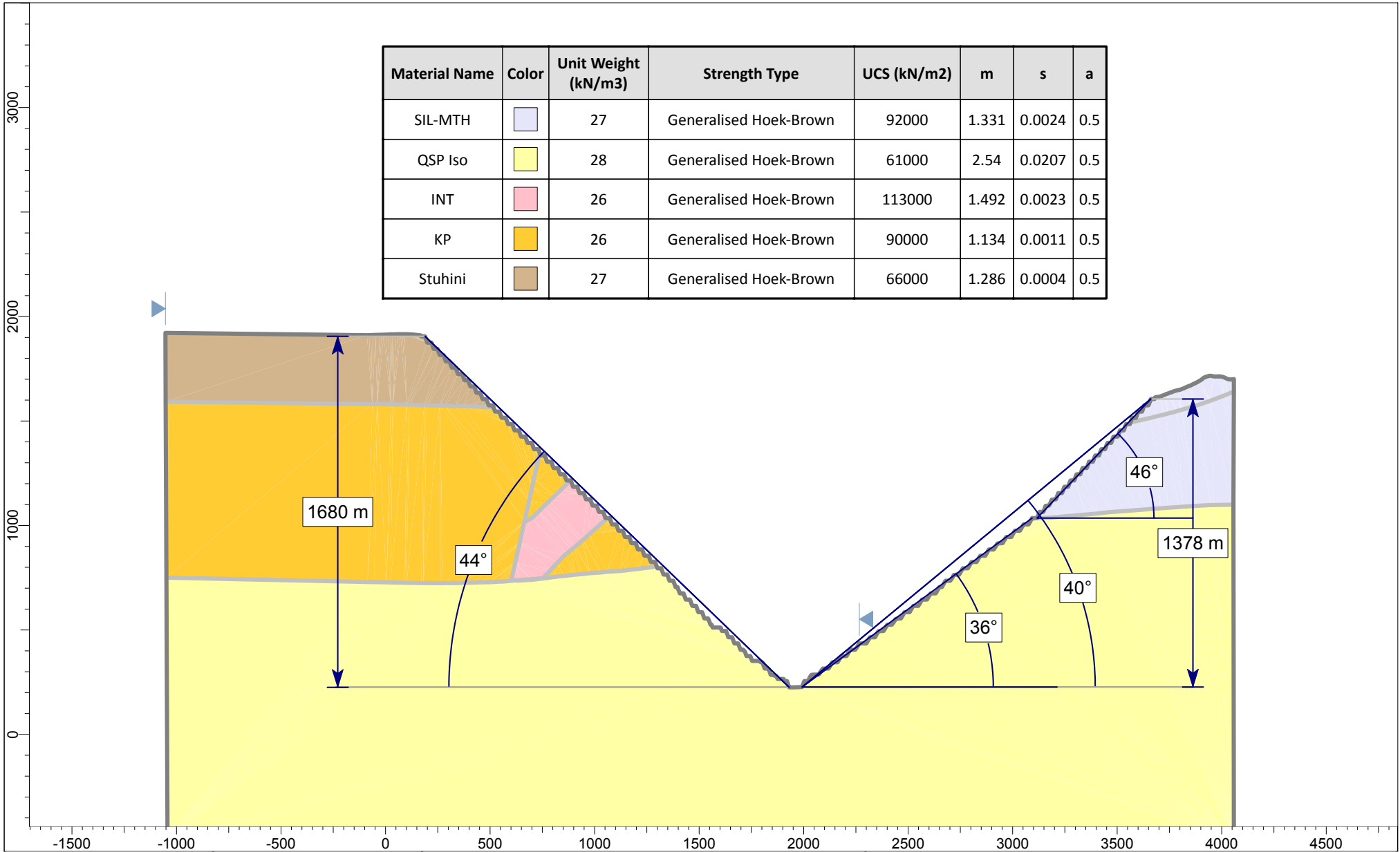

SCALE: 1:25000	DESIGNED: MAB	 <b>BGC ENGINEERING INC.</b> AN APPLIED EARTH SCIENCES COMPANY	PROJECT: KSM PROJECT PRE-FEASIBILITY STUDY UPDATE - MITCHELL PIT SLOPE ADDENDUM AND CONFIRMATION
DATE: JUN 2011	CHECKED: DK		TITLE: PIT CHECKING SECTION A
DRAWN: MAB	APPROVED: HWN		PROJECT No.: 0638-006
<small>AS A MUTUAL PROTECTION TO OUR CLIENT, THE PUBLIC, AND OURSELVES, ALL REPORTS AND DRAWINGS ARE SUBMITTED FOR THE CONFIDENTIAL INFORMATION OF OUR CLIENT FOR A SPECIFIC PROJECT. AUTHORIZATION FOR ANY USE AND/OR PUBLICATION OF THIS REPORT OR ANY DATA, STATEMENTS, CONCLUSIONS OR ABSTRACTS FROM OR REGARDING OUR REPORTS AND DRAWINGS, THROUGH ANY FORM OF PRINT OR ELECTRONIC MEDIA, INCLUDING WITHOUT LIMITATION, POSTING OR REPRODUCTION OF SAME ON ANY WEBSITE, IS RESERVED PENDING BOOKS WRITTEN APPROVAL. IF THIS REPORT IS ISSUED IN ELECTRONIC FORMAT, AN ORIGINAL PAPER COPY IS ON FILE AT BGC ENGINEERING INC. AND THAT COPY IS THE PRIMARY REFERENCE WITH PRECEDENCE OVER ANY ELECTRONIC COPY OF THE DOCUMENT, OR ANY EXTRACTS FROM OUR DOCUMENTS PUBLISHED BY OTHERS.</small>		CLIENT: SEABRIDGE GOLD INC	

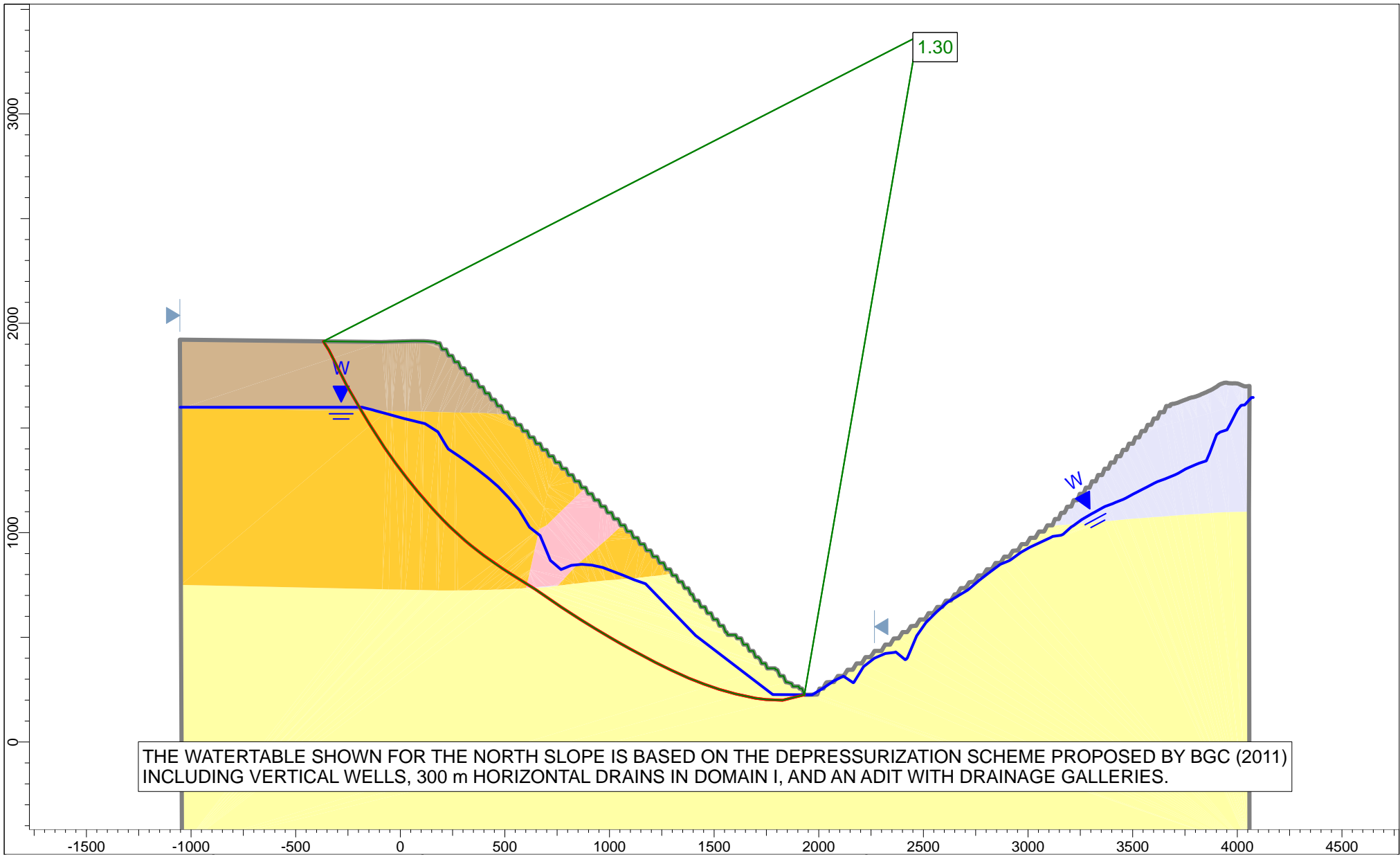

THE WATERTABLE SHOWN FOR THE NORTH SLOPE IS BASED ON THE DEPRESSURIZATION SCHEME PROPOSED BY BGC (2011) INCLUDING VERTICAL WELLS, 300 m HORIZONTAL DRAINS IN DOMAIN I, AND AN ADIT WITH DRAINAGE GALLERIES.

SCALE:	1:25000	DESIGNED:	MAB		PROJECT:	KSM PROJECT PRE-FEASIBILITY STUDY UPDATE - MITCHELL PIT SLOPE PARAMETER ADDENDUM AND CONFIRMATION	
DATE:	JUN 2011	CHECKED:	DK		TITLE:	PIT CHECKING SECTION A	
DRAWN:	MAB	APPROVED:	HWN		PROJECT No.:	0638-006	FILE NAME:
<small>AS A MUTUAL PROTECTION TO OUR CLIENT, THE PUBLIC, AND OURSELVES, ALL REPORTS AND DRAWINGS ARE SUBMITTED FOR THE CONFIDENTIAL INFORMATION OF OUR CLIENT FOR A SPECIFIC PROJECT. AUTHORIZATION FOR ANY USE AND/OR PUBLICATION OF THIS REPORT OR ANY DATA, STATEMENTS, CONCLUSIONS OR ABSTRACTS FROM OR REGARDING OUR REPORTS AND DRAWINGS, THROUGH ANY FORM OF PRINT OR ELECTRONIC MEDIA, INCLUDING WITHOUT LIMITATION, POSTING OR REPRODUCTION OF SAME ON ANY WEBSITE, IS RESERVED PENDING BGC'S WRITTEN APPROVAL. IF THIS REPORT IS ISSUED IN ELECTRONIC FORMAT, AN ORIGINAL PAPER COPY IS ON FILE AT BGC ENGINEERING INC. AND THAT COPY IS THE PRIMARY REFERENCE WITH PRECEDENCE OVER ANY ELECTRONIC COPY OF THE DOCUMENT, OR ANY EXTRACTS FROM OUR DOCUMENTS PUBLISHED BY OTHERS.</small>				CLIENT:	SEABRIDGE GOLD INC		

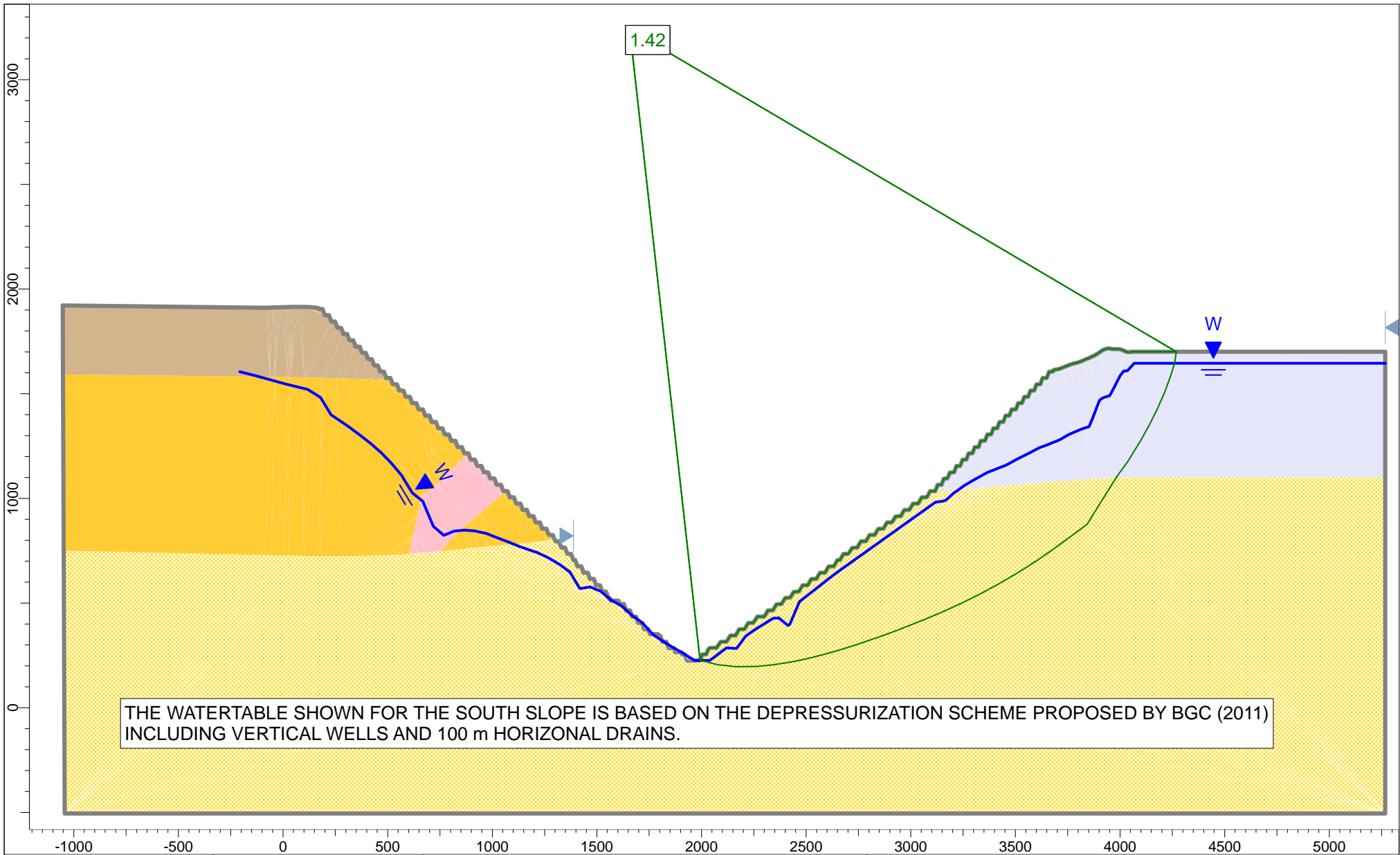

THE WATERTABLE SHOWN FOR THE SOUTH SLOPE IS BASED ON THE DEPRESSURIZATION SCHEME PROPOSED BY BGC (2011) INCLUDING VERTICAL WELLS AND 100 m HORIZONTAL DRAINS.

SCALE:	1:25000	DESIGNED:	MAB		PROJECT:	KSM PROJECT PRE-FEASIBILITY STUDY UPDATE - MITCHELL PIT SLOPE PARAMETER ADDENDUM AND CONFIRMATION	
DATE:	JUN 2011	CHECKED:	DK		TITLE:	PIT CHECKING SECTION A	
DRAWN:	MAB	APPROVED:	HWN		PROJECT No.:	0638-006	FILE NAME:
<small>AS A MUTUAL PROTECTION TO OUR CLIENT, THE PUBLIC, AND OURSELVES, ALL REPORTS AND DRAWINGS ARE SUBMITTED FOR THE CONFIDENTIAL INFORMATION OF OUR CLIENT FOR A SPECIFIC PROJECT. AUTHORIZATION FOR ANY USE AND/OR PUBLICATION OF THIS REPORT OR ANY DATA, STATEMENTS, CONCLUSIONS OR ABSTRACTS FROM OR REGARDING OUR REPORTS AND DRAWINGS, THROUGH ANY FORM OF PRINT OR ELECTRONIC MEDIA, INCLUDING WITHOUT LIMITATION, POSTING OR REPRODUCTION OF SAME ON ANY WEBSITE, IS RESERVED PENDING BOOKS WRITTEN APPROVAL. IF THIS REPORT IS ISSUED IN ELECTRONIC FORMAT, AN ORIGINAL PAPER COPY IS ON FILE AT BGC ENGINEERING INC. AND THAT COPY IS THE PRIMARY REFERENCE WITH PRECEDENCE OVER ANY ELECTRONIC COPY OF THE DOCUMENT, OR ANY EXTRACTS FROM OUR DOCUMENTS PUBLISHED BY OTHERS.</small>				CLIENT:	SEABRIDGE GOLD INC		

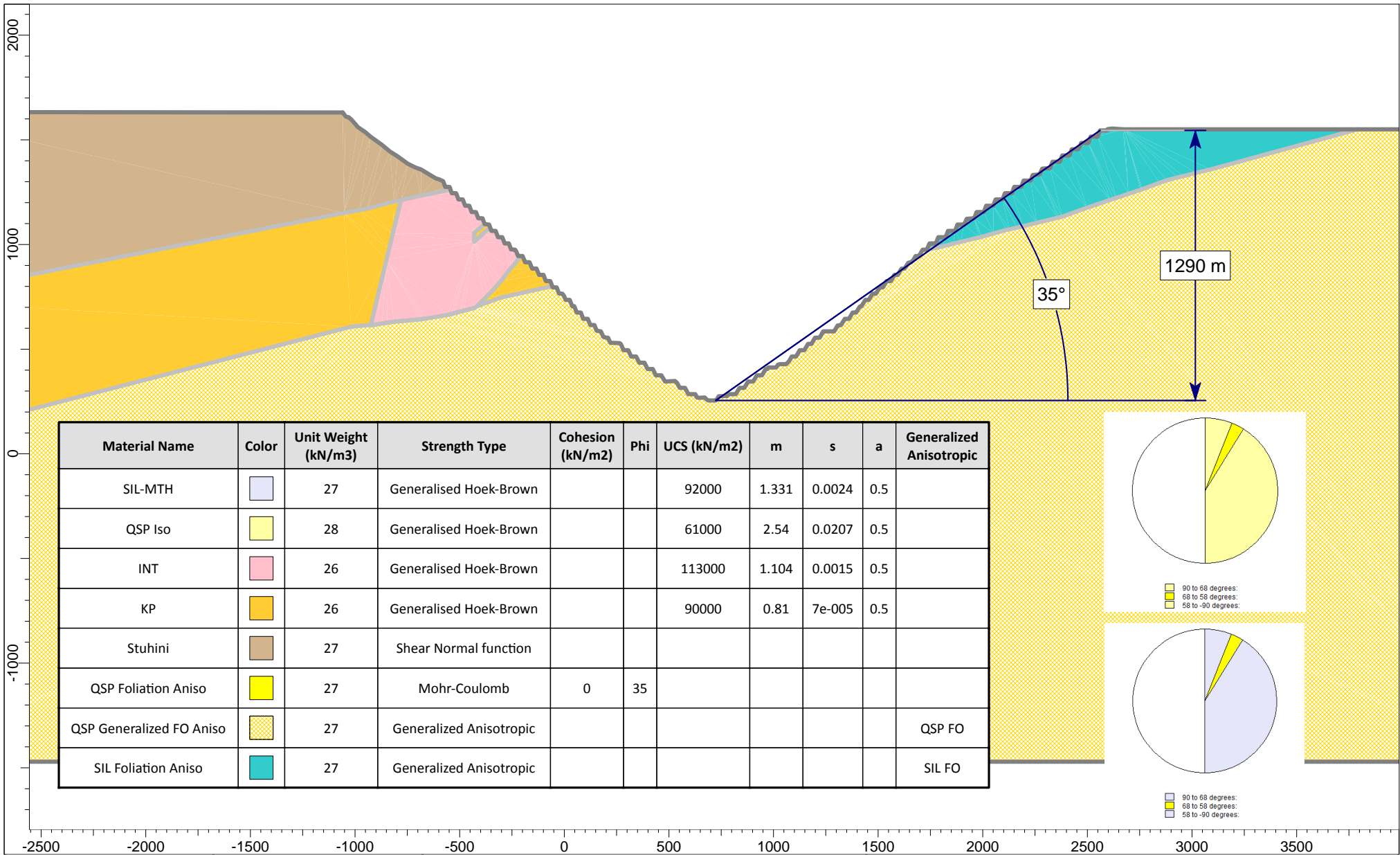

Material Name	Color	Unit Weight (kN/m <sup>3</sup> )	Strength Type	Cohesion (kN/m <sup>2</sup> )	Phi	UCS (kN/m <sup>2</sup> )	m	s	a	Generalized Anisotropic
SIL-MTH		27	Generalised Hoek-Brown			92000	1.331	0.0024	0.5	
QSP Iso		28	Generalised Hoek-Brown			61000	2.54	0.0207	0.5	
INT		26	Generalised Hoek-Brown			113000	1.104	0.0015	0.5	
KP		26	Generalised Hoek-Brown			90000	0.81	7e-005	0.5	
Stuhini		27	Shear Normal function							
QSP Foliation Aniso		27	Mohr-Coulomb	0	35					
QSP Generalized FO Aniso		27	Generalized Anisotropic							QSP FO
SIL Foliation Aniso		27	Generalized Anisotropic							SIL FO

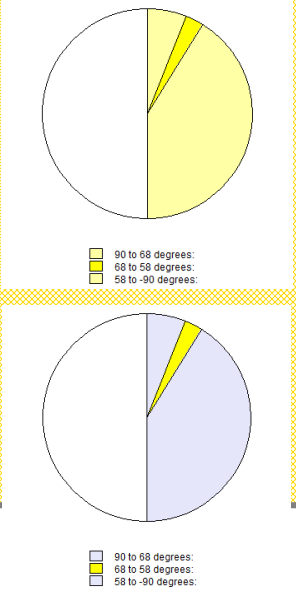

SCALE: 1:25000	DESIGNED: MAB		PROJECT: KSM PROJECT PRE-FEASIBILITY STUDY UPDATE
DATE: JUN 2011	CHECKED: DK		- MITCHELL PIT SLOPE PARAMETER ADDENDUM AND CONFIRMATION
DRAWN: MAB	APPROVED: HWN		TITLE: PIT CHECKING - SECTION B
<small>AS A MUTUAL PROTECTION TO OUR CLIENT, THE PUBLIC, AND OURSELVES, ALL REPORTS AND DRAWINGS ARE SUBMITTED FOR THE CONFIDENTIAL INFORMATION OF OUR CLIENT FOR A SPECIFIC PROJECT. AUTHORIZATION FOR ANY USE AND/OR PUBLICATION OF THIS REPORT OR ANY DATA, STATEMENTS, CONCLUSIONS OR ABSTRACTS FROM OR REGARDING OUR REPORTS AND DRAWINGS, THROUGH ANY FORM OF PRINT OR ELECTRONIC MEDIA, INCLUDING WITHOUT LIMITATION, POSTING OR REPRODUCTION OF SAME ON ANY WEBSITE, IS RESERVED PENDING BGC'S WRITTEN APPROVAL. IF THIS REPORT IS ISSUED IN ELECTRONIC FORMAT, AN ORIGINAL PAPER COPY IS ON FILE AT BGC ENGINEERING INC. AND THAT COPY IS THE PRIMARY REFERENCE WITH PRECEDENCE OVER ANY ELECTRONIC COPY OF THE DOCUMENT, OR ANY EXTRACTS FROM OUR DOCUMENTS PUBLISHED BY OTHERS.</small>		CLIENT: SEABRIDGE GOLD INC	PROJECT No.: 0638-006
			FILE NAME: Mitchell Section B0.slim

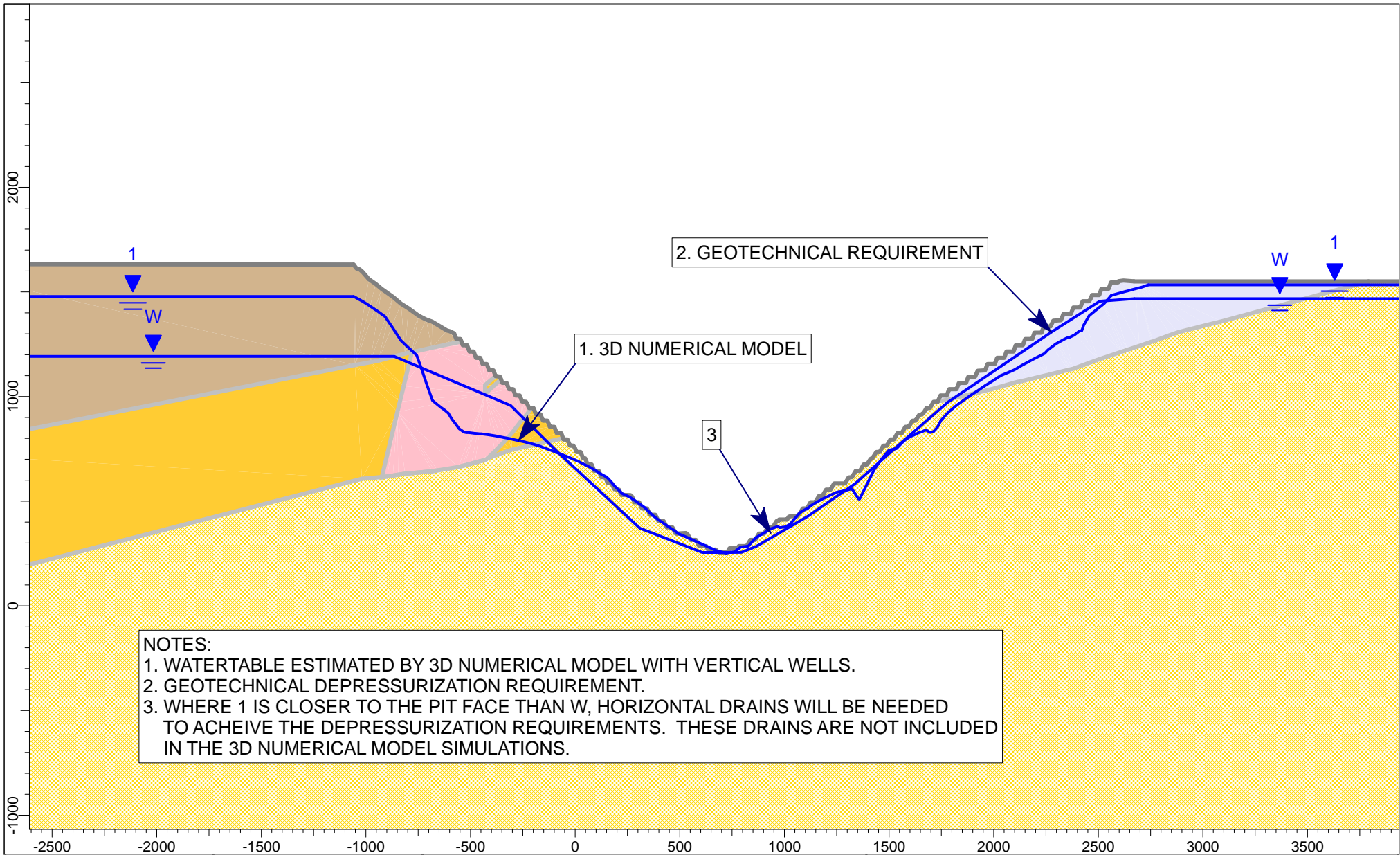

**NOTES:**  
 1. WATERTABLE ESTIMATED BY 3D NUMERICAL MODEL WITH VERTICAL WELLS.  
 2. GEOTECHNICAL DEPRESSURIZATION REQUIREMENT.  
 3. WHERE 1 IS CLOSER TO THE PIT FACE THAN W, HORIZONTAL DRAINS WILL BE NEEDED TO ACHEIVE THE DEPRESSURIZATION REQUIREMENTS. THESE DRAINS ARE NOT INCLUDED IN THE 3D NUMERICAL MODEL SIMULATIONS.

SCALE: 1:25000	DESIGNED: MAB		PROJECT: KSM PROJECT PRE-FEASIBILITY STUDY UPDATE - MITCHELL PIT SLOPE PARAMETER ADDENDUM AND CONFIRMATION
DATE: JUN 2011	CHECKED: DK		TITLE: PIT CHECKING - SECTION B WT COMPARISON
DRAWN: MAB	APPROVED: HWN		PROJECT No.: 0638-006
<small>AS A MUTUAL PROTECTION TO OUR CLIENT, THE PUBLIC, AND OURSELVES, ALL REPORTS AND DRAWINGS ARE SUBMITTED FOR THE CONFIDENTIAL INFORMATION OF OUR CLIENT FOR A SPECIFIC PROJECT. AUTHORIZATION FOR ANY USE AND/OR PUBLICATION OF THIS REPORT OR ANY DATA, STATEMENTS, CONCLUSIONS OR ABSTRACTS FROM OR REGARDING OUR REPORTS AND DRAWINGS, THROUGH ANY FORM OF PRINT OR ELECTRONIC MEDIA, INCLUDING WITHOUT LIMITATION, POSTING OR REPRODUCTION OF SAME ON ANY WEBSITE, IS RESERVED PENDING BOOKS WRITTEN APPROVAL. IF THIS REPORT IS ISSUED IN ELECTRONIC FORMAT, AN ORIGINAL PAPER COPY IS ON FILE AT BGC ENGINEERING INC. AND THAT COPY IS THE PRIMARY REFERENCE WITH PRECEDENCE OVER ANY ELECTRONIC COPY OF THE DOCUMENT, OR ANY EXTRACTS FROM OUR DOCUMENTS PUBLISHED BY OTHERS.</small>		CLIENT: SEABRIDGE GOLD INC	

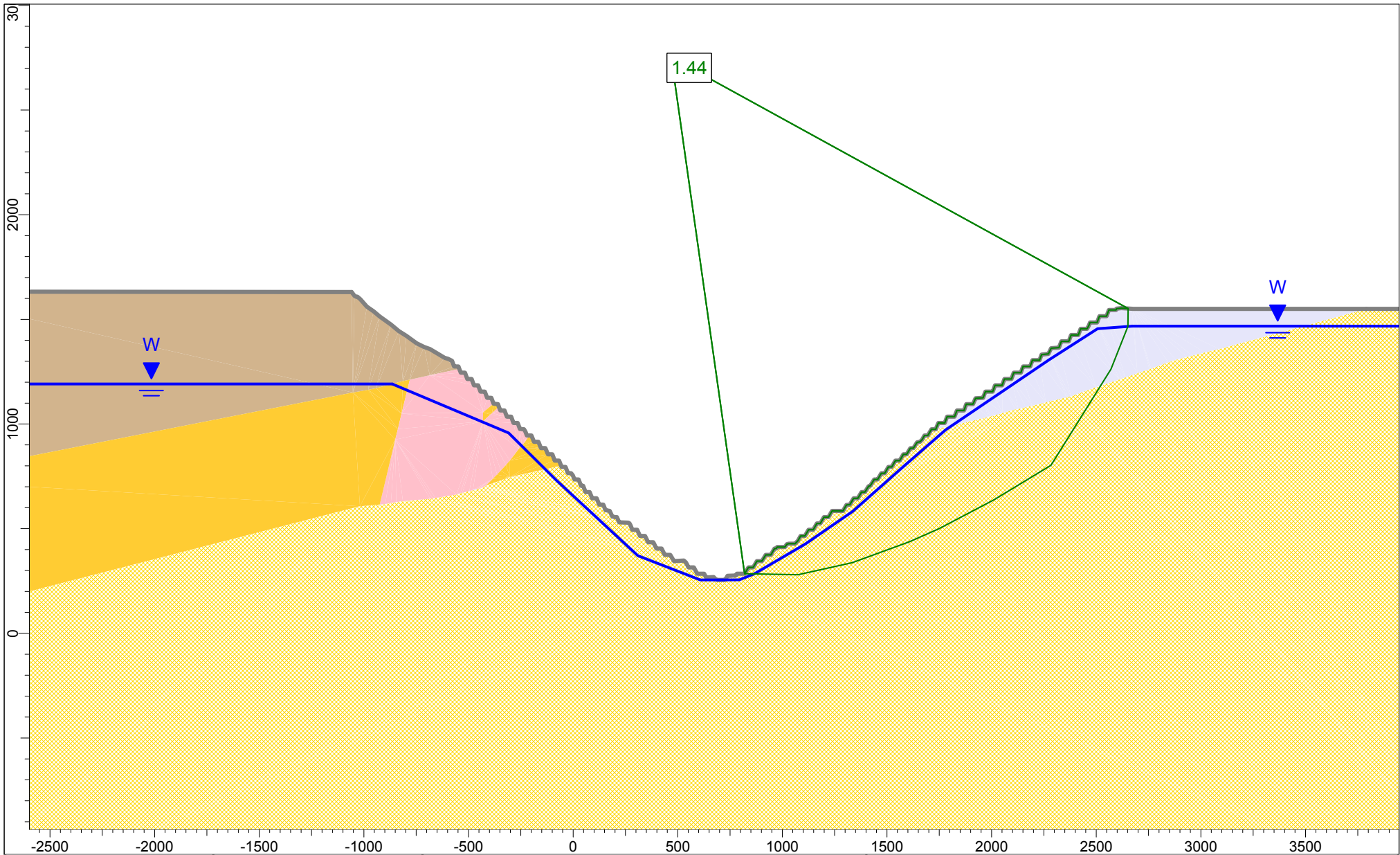

SCALE:	1:25000	DESIGNED:	MAB		PROJECT:	KSM PROJECT PRE-FEASIBILITY STUDY UPDATE - MITCHELL PIT SLOPE PARAMETER ADDENDUM AND CONFIRMATION	
DATE:	JUN 2011	CHECKED:	DK		TITLE:	PIT CHECKING - SECTION B	
DRAWN:	MAB	APPROVED:	HWN		CLIENT:	SEABRIDGE GOLD INC	PROJECT No.:
<small>AS A MUTUAL PROTECTION TO OUR CLIENT, THE PUBLIC, AND OURSELVES, ALL REPORTS AND DRAWINGS ARE SUBMITTED FOR THE CONFIDENTIAL INFORMATION OF OUR CLIENT FOR A SPECIFIC PROJECT. AUTHORIZATION FOR ANY USE AND/OR PUBLICATION OF THIS REPORT OR ANY DATA, STATEMENTS, CONCLUSIONS OR ABSTRACTS FROM OR REGARDING OUR REPORTS AND DRAWINGS, THROUGH ANY FORM OF PRINT OR ELECTRONIC MEDIA, INCLUDING WITHOUT LIMITATION, POSTING OR REPRODUCTION OF SAME ON ANY WEBSITE, IS RESERVED PENDING BOOKS WRITTEN APPROVAL. IF THIS REPORT IS ISSUED IN ELECTRONIC FORMAT, AN ORIGINAL PAPER COPY IS ON FILE AT BGC ENGINEERING INC. AND THAT COPY IS THE PRIMARY REFERENCE WITH PRECEDENCE OVER ANY ELECTRONIC COPY OF THE DOCUMENT, OR ANY EXTRACTS FROM OUR DOCUMENTS PUBLISHED BY OTHERS.</small>				FILE NAME:	Mitchell Section B1.slim		

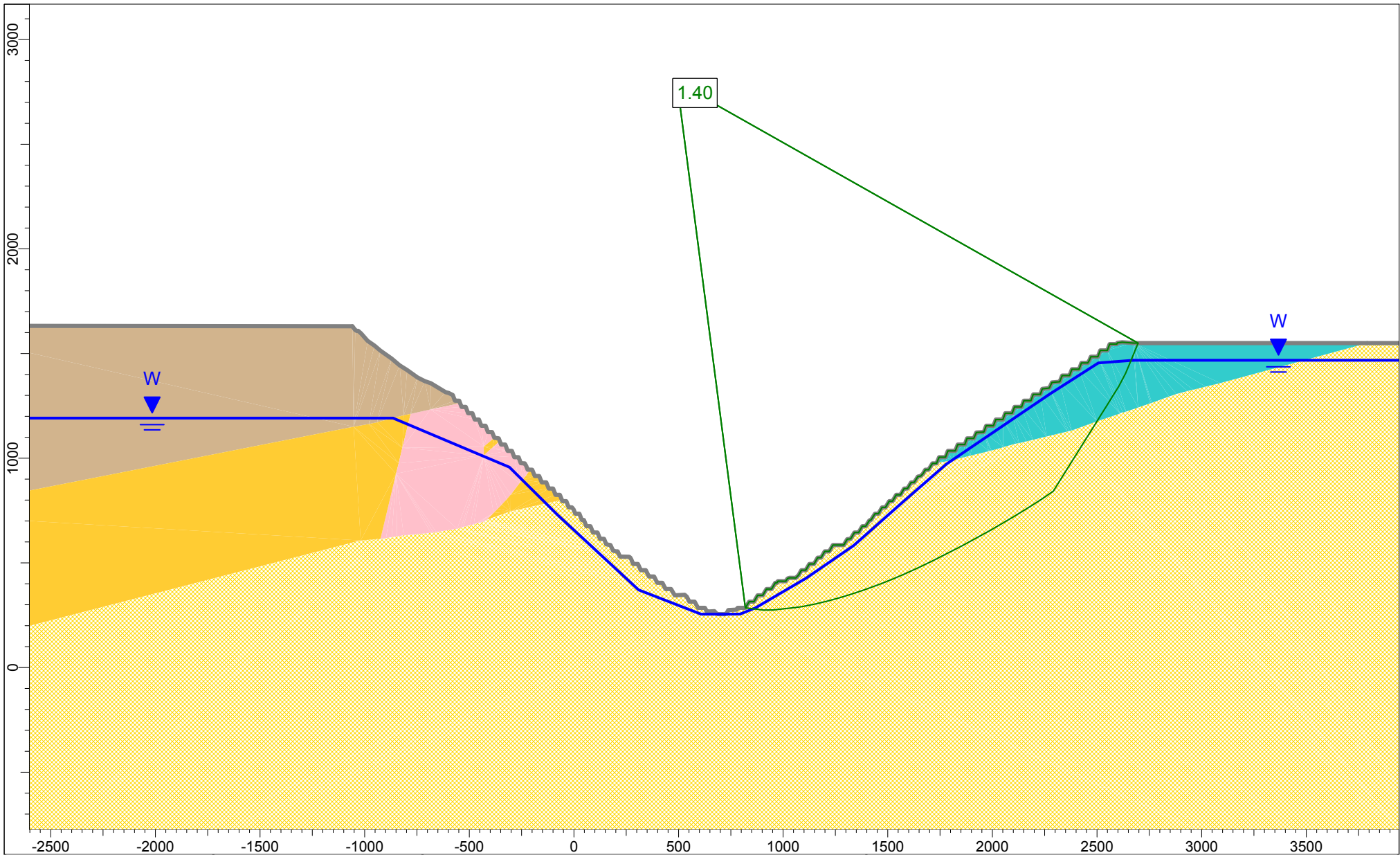

SCALE:	1:25000	DESIGNED:	MAB		PROJECT:	KSM PROJECT PRE-FEASIBILITY STUDY UPDATE - MITCHELL PIT SLOPE PARAMETER ADDENDUM AND CONFIRMATION	
DATE:	JUN 2011	CHECKED:	DK		TITLE:	PIT CHECKING - SECTION B	
DRAWN:	MAB	APPROVED:	HWN		PROJECT No.:	0638-006	FILE NAME:
<small>AS A MUTUAL PROTECTION TO OUR CLIENT, THE PUBLIC, AND OURSELVES, ALL REPORTS AND DRAWINGS ARE SUBMITTED FOR THE CONFIDENTIAL INFORMATION OF OUR CLIENT FOR A SPECIFIC PROJECT. AUTHORIZATION FOR ANY USE AND/OR PUBLICATION OF THIS REPORT OR ANY DATA, STATEMENTS, CONCLUSIONS OR ABSTRACTS FROM OR REGARDING OUR REPORTS AND DRAWINGS, THROUGH ANY FORM OF PRINT OR ELECTRONIC MEDIA, INCLUDING WITHOUT LIMITATION, POSTING OR REPRODUCTION OF SAME ON ANY WEBSITE, IS RESERVED PENDING BGC'S WRITTEN APPROVAL. IF THIS REPORT IS ISSUED IN ELECTRONIC FORMAT, AN ORIGINAL PAPER COPY IS ON FILE AT BGC ENGINEERING INC. AND THAT COPY IS THE PRIMARY REFERENCE WITH PRECEDENCE OVER ANY ELECTRONIC COPY OF THE DOCUMENT, OR ANY EXTRACTS FROM OUR DOCUMENTS PUBLISHED BY OTHERS.</small>				CLIENT:	SEABRIDGE GOLD INC		



Material Name	Color	Unit Weight (kN/m <sup>3</sup> )	Strength Type	UCS (kN/m <sup>2</sup> )	m	s	a
QSP Iso		28	Generalised Hoek-Brown	61000	2.54	0.0207	0.5

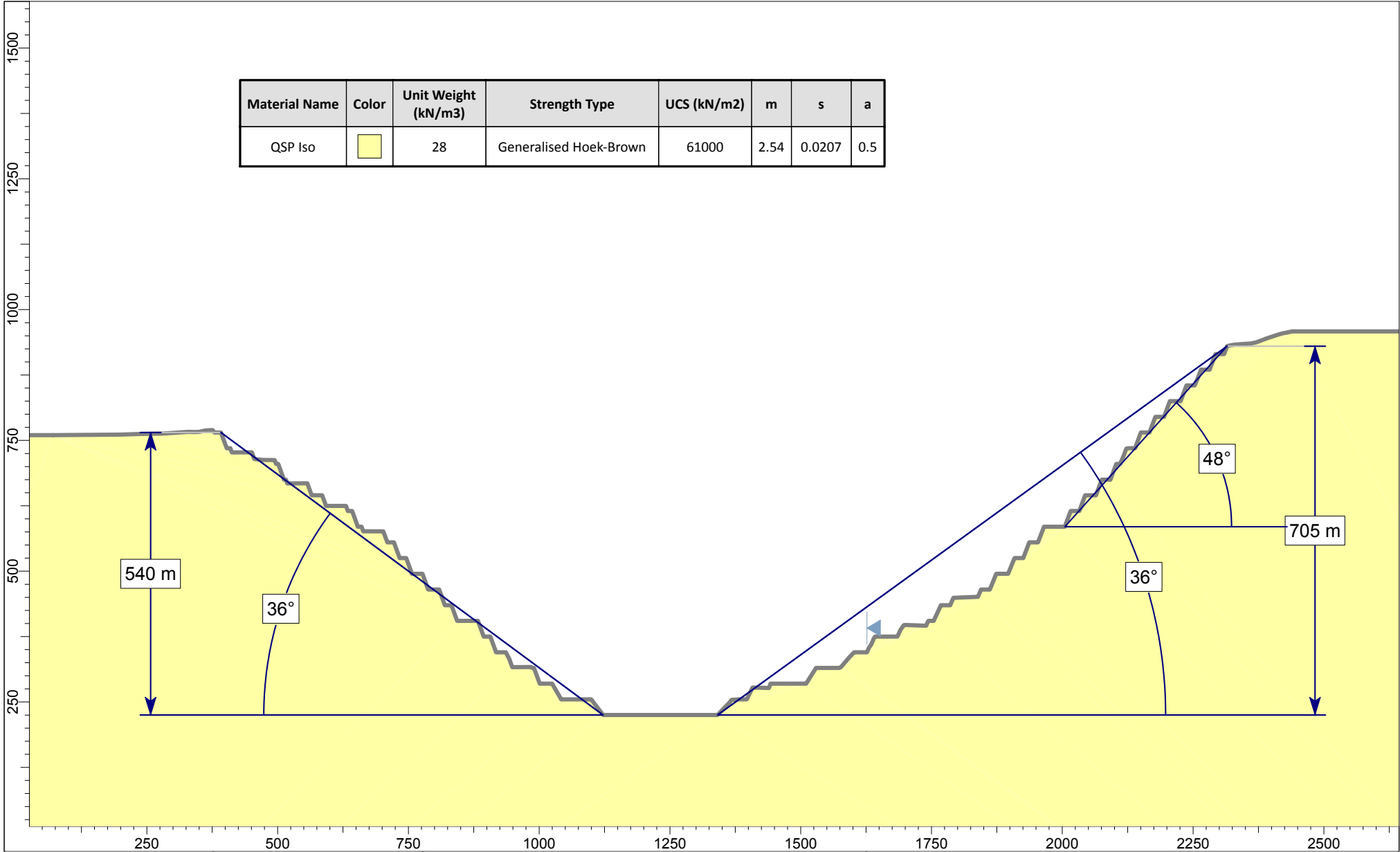

SCALE: 1:10000	DESIGNED: MAB	 <b>BGC ENGINEERING INC.</b> AN APPLIED EARTH SCIENCES COMPANY	PROJECT: KSM PROJECT PRE-FEASIBILITY STUDY UPDATE	
DATE: JUN 2011	CHECKED: DK		TITLE: - MITCHELL PIT SLOPE PARAMETER ADDENDUM AND CONFIRMATION	
DRAWN: MAB	APPROVED: HWN		TITLE: PIT CHECKING - SECTION C	
<small>AS A MUTUAL PROTECTION TO OUR CLIENT, THE PUBLIC, AND OURSELVES, ALL REPORTS AND DRAWINGS ARE SUBMITTED FOR THE CONFIDENTIAL INFORMATION OF OUR CLIENT FOR A SPECIFIC PROJECT. AUTHORIZATION FOR ANY USE AND/OR PUBLICATION OF THIS REPORT OR ANY DATA, STATEMENTS, CONCLUSIONS OR ABSTRACTS FROM OR REGARDING OUR REPORTS AND DRAWINGS, THROUGH ANY FORM OF PRINT OR ELECTRONIC MEDIA, INCLUDING WITHOUT LIMITATION, POSTING OR REPRODUCTION OF SAME ON ANY WEBSITE, IS RESERVED PENDING BGC'S WRITTEN APPROVAL. IF THIS REPORT IS ISSUED IN ELECTRONIC FORMAT, AN ORIGINAL PAPER COPY IS ON FILE AT BGC ENGINEERING INC. AND THAT COPY IS THE PRIMARY REFERENCE WITH PRECEDENCE OVER ANY ELECTRONIC COPY OF THE DOCUMENT, OR ANY EXTRACTS FROM OUR DOCUMENTS PUBLISHED BY OTHERS.</small>		CLIENT: SEABRIDGE GOLD INC	PROJECT No.: 0638-006	FILE NAME: Mitchell Section C0.slim

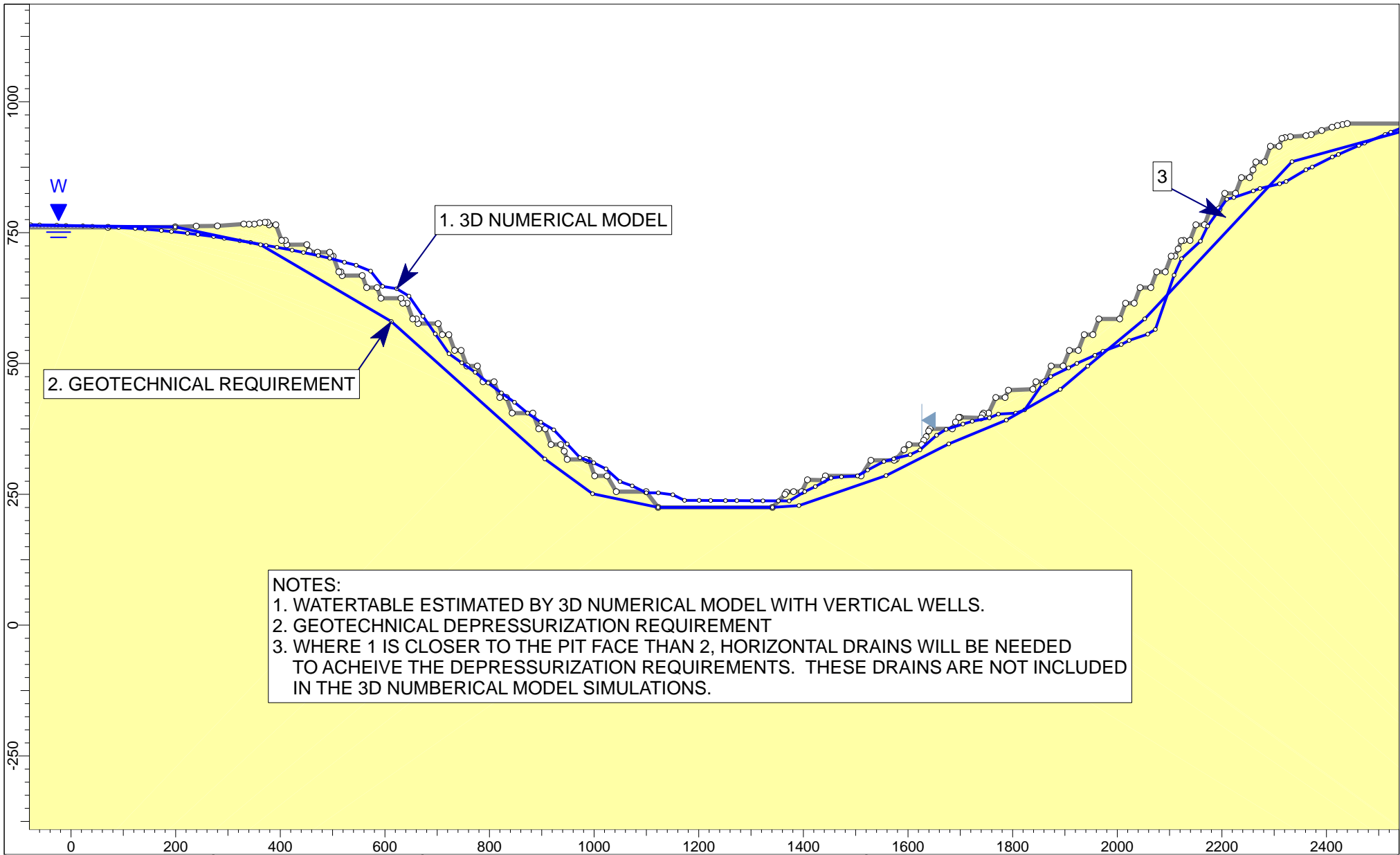

SCALE: 1:10000	DESIGNED: MAB		PROJECT: KSM PROJECT PRE-FEASIBILITY STUDY UPDATE - MITCHELL PIT SLOPE PARAMETER ADDENDUM AND CONFIRMATION
DATE: JUN 2011	CHECKED: DK		TITLE: PIT CHECKING - SECTION C WT COMPARISON
DRAWN: MAB	APPROVED: HWN		PROJECT No.: 0638-006
<small>AS A MUTUAL PROTECTION TO OUR CLIENT, THE PUBLIC, AND OURSELVES, ALL REPORTS AND DRAWINGS ARE SUBMITTED FOR THE CONFIDENTIAL INFORMATION OF OUR CLIENT FOR A SPECIFIC PROJECT. AUTHORIZATION FOR ANY USE AND/OR PUBLICATION OF THIS REPORT OR ANY DATA, STATEMENTS, CONCLUSIONS OR ABSTRACTS FROM OR REGARDING OUR REPORTS AND DRAWINGS, THROUGH ANY FORM OF PRINT OR ELECTRONIC MEDIA, INCLUDING WITHOUT LIMITATION, POSTING OR REPRODUCTION OF SAME ON ANY WEBSITE, IS RESERVED PENDING BGC'S WRITTEN APPROVAL. IF THIS REPORT IS ISSUED IN ELECTRONIC FORMAT, AN ORIGINAL PAPER COPY IS ON FILE AT BGC ENGINEERING INC. AND THAT COPY IS THE PRIMARY REFERENCE WITH PRECEDENCE OVER ANY ELECTRONIC COPY OF THE DOCUMENT, OR ANY EXTRACTS FROM OUR DOCUMENTS PUBLISHED BY OTHERS.</small>		CLIENT: SEABRIDGE GOLD INC	

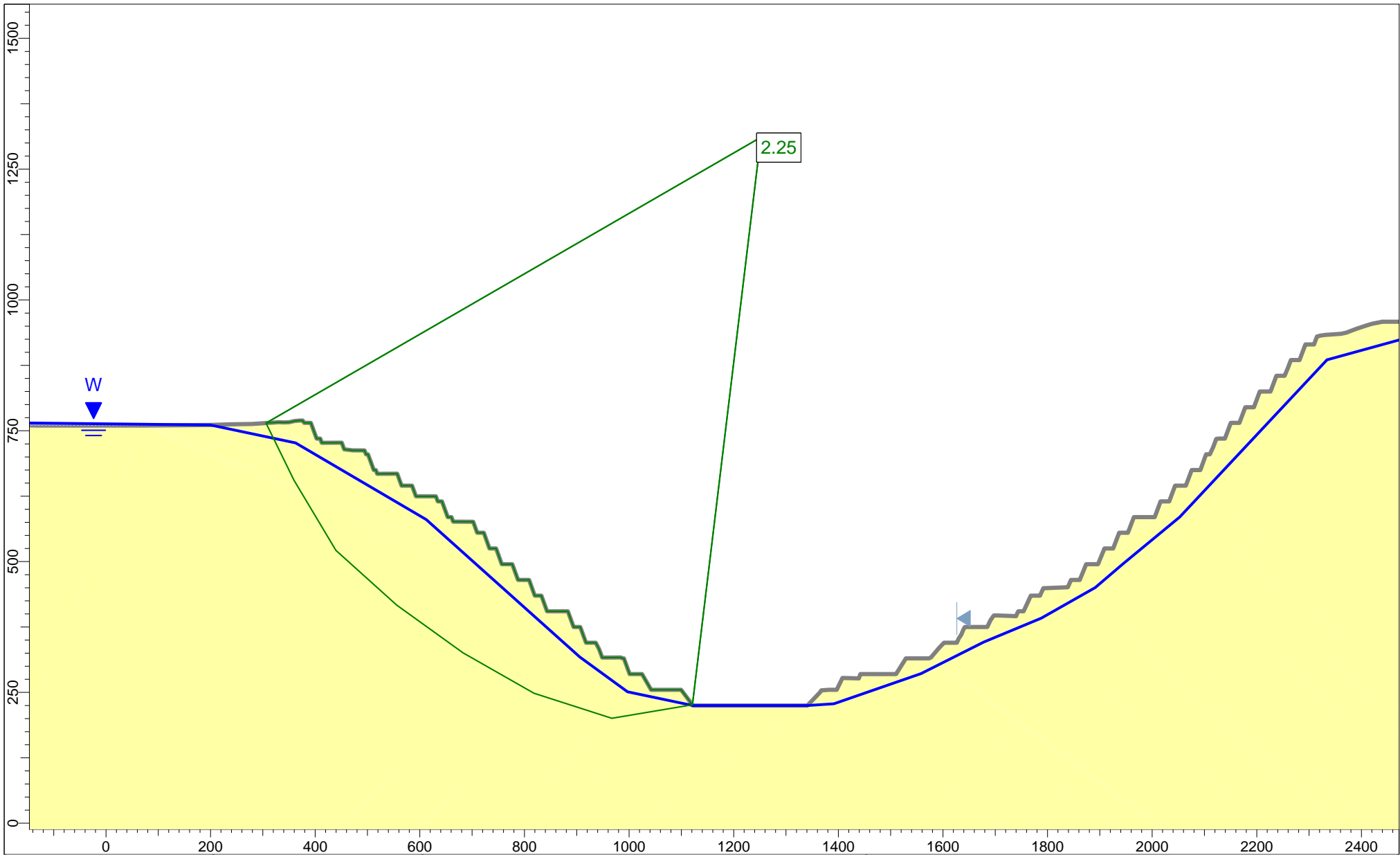

SCALE: 1:10000	DESIGNED: MAB		PROJECT: KSM PROJECT PRE-FEASIBILITY STUDY UPDATE - MITCHELL PIT SLOPE PARAMETER ADDENDUM AND CONFIRMATION
DATE: JUN 2011	CHECKED: DK		TITLE: PIT CHECKING - SECTION C
DRAWN: MAB	APPROVED: HWN		PROJECT No.: 0638-006
<small>AS A MUTUAL PROTECTION TO OUR CLIENT, THE PUBLIC, AND OURSELVES, ALL REPORTS AND DRAWINGS ARE SUBMITTED FOR THE CONFIDENTIAL INFORMATION OF OUR CLIENT FOR A SPECIFIC PROJECT. AUTHORIZATION FOR ANY USE AND/OR PUBLICATION OF THIS REPORT OR ANY DATA, STATEMENTS, CONCLUSIONS OR ABSTRACTS FROM OR REGARDING OUR REPORTS AND DRAWINGS, THROUGH ANY FORM OF PRINT OR ELECTRONIC MEDIA, INCLUDING WITHOUT LIMITATION, POSTING OR REPRODUCTION OF SAME ON ANY WEBSITE, IS RESERVED PENDING BGC'S WRITTEN APPROVAL. IF THIS REPORT IS ISSUED IN ELECTRONIC FORMAT, AN ORIGINAL PAPER COPY IS ON FILE AT BGC ENGINEERING INC. AND THAT COPY IS THE PRIMARY REFERENCE WITH PRECEDENCE OVER ANY ELECTRONIC COPY OF THE DOCUMENT, OR ANY EXTRACTS FROM OUR DOCUMENTS PUBLISHED BY OTHERS.</small>		CLIENT: SEABRIDGE GOLD INC	

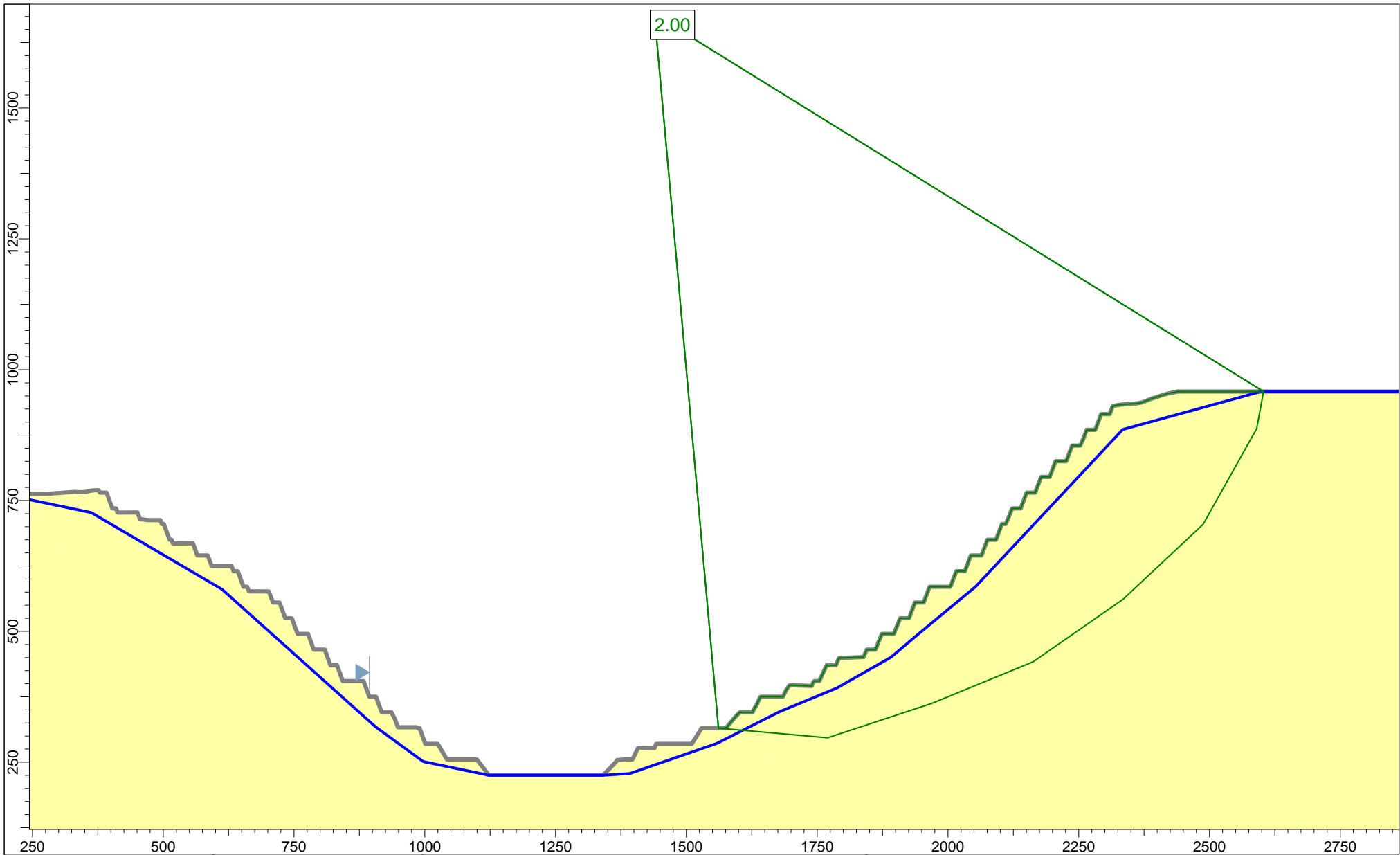

SCALE: 1:10000	DESIGNED: MAB	 <b>BGC ENGINEERING INC.</b> AN APPLIED EARTH SCIENCES COMPANY	PROJECT: KSM PROJECT PRE-FEASIBILITY STUDY UPDATE	
DATE: JUN 2011	CHECKED: DK		- MITCHELL PIT SLOPE PARAMETER ADDENDUM AND CONFIRMATION	
DRAWN: MAB	APPROVED: HWN		TITLE: PIT CHECKING - SECTION C	
<small>AS A MUTUAL PROTECTION TO OUR CLIENT, THE PUBLIC, AND OURSELVES, ALL REPORTS AND DRAWINGS ARE SUBMITTED FOR THE CONFIDENTIAL INFORMATION OF OUR CLIENT FOR A SPECIFIC PROJECT. AUTHORIZATION FOR ANY USE AND/OR PUBLICATION OF THIS REPORT OR ANY DATA, STATEMENTS, CONCLUSIONS OR ABSTRACTS FROM OR REGARDING OUR REPORTS AND DRAWINGS, THROUGH ANY FORM OF PRINT OR ELECTRONIC MEDIA, INCLUDING WITHOUT LIMITATION, POSTING OR REPRODUCTION OF SAME ON ANY WEBSITE, IS RESERVED PENDING BGC'S WRITTEN APPROVAL. IF THIS REPORT IS ISSUED IN ELECTRONIC FORMAT, AN ORIGINAL PAPER COPY IS ON FILE AT BGC ENGINEERING INC. AND THAT COPY IS THE PRIMARY REFERENCE WITH PRECEDENCE OVER ANY ELECTRONIC COPY OF THE DOCUMENT, OR ANY EXTRACTS FROM OUR DOCUMENTS PUBLISHED BY OTHERS.</small>		CLIENT: SEABRIDGE GOLD INC	PROJECT No.: 0638-006	FILE NAME: Mitchell Section C2.slim